



**ENVO
TECH**

**PRICES
2016**

IT	EN	DE	ES	FR	
Porta targa	Tail tidy	Kennzeichenhalter	Porta Matrícula	Support de Plaque	4
Accessori porta targa	Tail tidy accessories	Kennzeichenzubehör	Porta Matrícula y Accesorios	Accessoires Support de Plaque	8
Tamponi paratelaio	Frame slider	Sturzpads	Protectores Anticaida	Roulettes de Protection	10
Tappi cinghia	Aluminium plugs	Aluminium Ösenschrauben	Enganche Cinchas	Bouchons Pour Sangles	10
Protezione motore	Engine protector	Motorschützer	Protectores Motor	Protections Moteur	14
Cover carter motore T-Max	T-Max engine side cover	T-Max Motorschützer	Tapa Motor T-Max	Couvercle lateral de moteur T-Max	15
Cover radiatore	Radiator guard	Kühlerschutz	Protector de radiador	Grille protection radiateur	15
Protezione pompa acqua	Water pump cover	Wasserpumpen - Abdeckung	Protector Bomba Agua	Protection pompe à eau	15
Protezioni forcelle	Fork Protector	Sturzpad Nabenabdeckung	Protectores de horquilla	Protections fourche	16
Cover perno ruota	Wheel cover	Tachsabdeckungen	Cono eje trasero	Cache axe de roue	17
Cover pignone	Pignon cover	Schutz für Antriebsritzel	Protector Piñón	Couvercle de Pignon	17
Protezione strumentazione Motech	Protection case Motech equipment	Motech Instrumentierung schützer	Carcasa protectora cuadro instrumentos Motech	Protection instrumentation Motech	17
Leva freno a mano	Parking brake	Handbremshebel	Leva freno aparcamiento	Leva du frein du parking	18
Piastra di sterzo	Top Yoke	Gabelbrücke	Tija	Colonne de Direction	18
Tappo liquido freno	Fluid tank cap	Deckel für den Bremsflüssigkeitsbehälter	Tapa Deposito Liquido Freno	Couvercle Réservoir Frein	19
Serbatoi fluido	Fluid Reservoirs	Flüssigkeitsbehälter	Depósito Fluidos	Réservoirs de fluide	20
Staffe supporto serbatoi fluido	Fluid tanks Brackets	Halterung Bremsflüssigkeitsbehälter	Pletina sujeción depósito líquido	Support de Montage pour les Reservoir	21
Tappi specchio	Mirror hole caps	Spiegel teile	Tapas para retrovisores	Plaques pour retroviseurs	22
Manubri	Handlebar	Lenker	Manillares	Guidon	23
Contrappesi	Handlebarends	Lenkerenden gewichte	Contrapesos	Embouts de guidons	23
Contrappesi Bmw	Bmw handlebar	Lenkerenden gewichte Bmw	Contrapesos Bmw	Embouts de guidons Bmw	25
Nottolini cavalletto	Paddock stands bobbins	Aufnahmehulsen	Soporte de cabaletes	Diabolos	25
Tappi benzina	Fuel caps	Tankdeckel	Tapón Depósito	Trappe à essence	27
Blocchetti tendicatena	Chain adjuster	Kettenspanner	Bloques Tensa Cadena	Tendeurs de Chaîne	32
Kit smontaggio rapido	Rapid wheel change kit	Rad-schnellwechsel-kit	Sistema desmontaje rápido rueda	Kit sostitution rapide roue	33
Tappi olio	Oil filler cap	Öl-Einfüllschraube	Tapón Aceite	Bouchon de Carter D'huile	34
Dadi in Ergal	Ergal Nuts	Ergal Achsmutter	Tuerca en Ergal	Ecrou en Ergal	36
Portacorona	Sprocket carrier	Ritzel	Porta corona	Porte couronne	41
Viteria in Ergal	Ergal bolts	Schraubensätze	Tornillería Ergal	Visserie Ergal	42
Cool stripes	Cool stripes	Cool stripes	Cool stripes	Cool stripes	57
Accessori racing	Racing accessories	Racing Zubehör	Accesorios racing	Accessoires Racing	58
Pulsantiera	Switch gear	Schaltanlage	Pulsador	Boutons de commande	59
Accessori Ducati	Ducati Accessories	Duacti Zubehör	Accesorios Ducati	Accessoires Ducati	60
Condizioni di vendita	Sale conditions	Geschäftsbedingungen	Condiciones de Venta	Conditions de Ventas	62

PORTA TARGA / TAIL TIDY / KENNZEICHENHALTER / PORTA MATRÍCULA / SUPPORT DE PLAQUE

TUTTI I PORTATARGA NON SONO COMPRESIVI DI LUCE TARGA A LED (dettagli p. 8)
 ALL TAIL TIDIES DO NOT INCLUDE LED LIGHT (details p. 8)
 ALLE KENNZEICHENHALTERN NICHT ENTHALTEN LED LIGHT (details p. 8)
 LOS PORTA MATRÍCULA NO INCLUYEN LA LUZ DE MATRÍCULA (detalles p. 8)
 TOUS LES SUPPORTS DE PLAQUE NE COMPRENDENT PAS L'ÉCLAIRAGE DE PLAQUE (détails p. 8)

MODEL	YEAR	CODE	EURO w/o tax
CAPONORD 1200	'13 -'15	ESTR-1005	70,00
DORSODURO 750	'08 -'12	ESTR-1002	70,00
DORSODURO 750	'13 -'15	ESTR-1007	85,00
DORSODURO 1200	'11 -'15	ESTR-1007	85,00
RS 125	'06 -'14	ESTR-1004	70,00
RS4 125	/	ESTR-1005	70,00
RSV4 FACTORY/R	'09 -'15	ESTR-1005	70,00
RSV4 RF NEW	'16	/	/
RSV4 RR/RF NEW	'15	/	/
SHIVER	'08 -'15	ESTR-1003	70,00
TUONO RSV 1000/R	'04 -'08	ESTR-1001	70,00
TUONO V4	/	ESTR-1005	70,00
TUONO V4 1100 FACTORY	'15	ESTR-1005	70,00
TUONO V4 1100 RR	'15	ESTR-1005	70,00
BN 302 NEW	/	ESTR-0604	65,00
BN 600 NEW	/	ESTR-0603	120,00
TNT 899	/	ESTR-0601	120,00
TNT 1130	/	ESTR-0601	120,00
TRE 1130 K	/	ESTR-0602	100,00
C 600 SPORT	/	ESTR-1103	120,00
G 310 R	'16	/	/
K1300R/S	'09 -'15	ESTR-1101	110,00
R 1200 R NEW	'15	ESTR-1106	200,00
R NINE T (4) (11) NEW	'14 -'15	ESTR-1105	180,00
S 1000 XR NEW	'15	ESTR-1107	/
S1000R (NUDA)	'14 -'15	ESTR-1102	90,00
S1000RR / HP4	'10 -'15	ESTR-1102	90,00
GPR 125 (12)	/	ESTR-1301	70,00
999 / 749 (3)	/	ESTR-0801	140,00
1198 / 1098 / 848 (2)	/	ESTR-0802	130,00
HYPERMOTARD	'07 -'12	ESTR-0804	70,00
HYPERMOTARD / SP	'13 -'15	ESTR-0812	80,00
HYPERMOTARD 939 NEW	'16	/	/
HYPERSTRADA	'13 -'15	ESTR-0812	80,00
HYPERSTRADA 939 NEW	'16	/	/
MONSTER 1200 R NEW	/	ESTR-0815	260,00
MONSTER 1200 S STRIPE NEW	/	ESTR-0815	260,00
MONSTER 1200 / S (4) NEW	/	ESTR-0813	270,00
MONSTER 1100 EVO (1)	'11 -'14	ESTR-0810	105,00
MONSTER 1100 (1)	'07 -'14	ESTR-0806	105,00
MONSTER 796 (1)	'07 -'14	ESTR-0806	105,00
MONSTER 821 (4) NEW	/	ESTR-0815	260,00

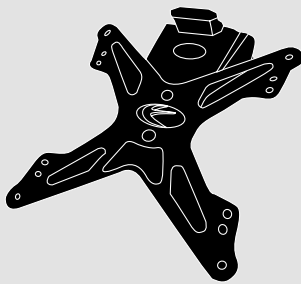

IT

- (1) Non include i supporti freccia perchè già integrati nel codone
- (2) Include alcune parti ricavate dal pieno
- (3) Include fanale posteriore a LED
- (4) Sconto differente
- (5) Compatibile con borse da viaggio
- (6) Solo per scarichi originali
- (7) Solo per scarichi aftermarket
- (8) Versione Premium (staffa dal pieno)
- (9) Versione Eco (in lamiera alluminio)
- (10) Luce Targa facoltativa
- (11) Non necessita della luce targa, già inclusa nel faro
- (12) Fino ad esaurimento scorte



BRAND

APRILIA

BENELLI

BMW

DERBY

DUCATI

BRAND

DUCATI

HARLEY DAVIDSON

HONDA

HUSQVARNA

KAWASAKI



MODEL	YEAR	CODE	EURO w/o tax
MONSTER 821 DARK (4) NEW	/	ESTR-0815	260,00
MONSTER 821 STRIPE (4) NEW	/	ESTR-0815	260,00
MONSTER 696 (1)	'07 -'14	ESTR-0805	105,00
MONSTER (4 fori) (10)	'03 -'06	ESTR-0803	70,00
MULTISTRADA 1200 (2)	'10 -'14	ESTR-0808	95,00
MULTISTRADA 1200 (2) (5)	'10 -'14	ESTR-0809	150,00
MULTISTRADA 1200	'15	ESTR-0814	/
MULTISTRADA 1200 ENDURO NEW	'16	/	/
PANIGALE 899	'12 -'15	ESTR-0811	190,00
PANIGALE 959 NEW	'16	/	/
PANIGALE 1199 (4)	'12 -'14	ESTR-0811	190,00
PANIGALE 1299 NEW	'15	ESTR-0811	190,00
SCRAMBLER NEW	'15	ESTR-0816	/
STREETFIGHTER 749	/	ESTR-0807	75,00
STREETFIGHTER 848	/	ESTR-0807	75,00
STREETFIGHTER 1098	/	ESTR-0807	75,00
X DIAVEL / S NEW	'16	/	/
SPORTSTER	/	ESTR-1201	95,00
AFRICA TWIN NEW	'16	/	/
CB 1000 R (8)	'08 -'15	ESTR-0110	140,00
CB 1000 R (9)	'08 -'15	ESTR-0113	70,00
CB 650 F	'14 -'15	ESTR-0119	75,00
CBR 1000 RR	'04 -'07	ESTR-0103	100,00
CBR 1000 RR	'08 -'09	ESTR-0111	149,00
CBR 1000 RR/SP (2)	'10 -'15	ESTR-0112	120,00
CBR 125 (12)	'11 -'14	ESTR-0114	70,00
CBR 250 (12)	'11 -'14	ESTR-0114	70,00
CBR 500 R NEW	'16	/	/
CBR 600 F (8)	'11 -'13	ESTR-0110	140,00
CBR 600 F (9)	'11 -'13	ESTR-0113	70,00
CBR 600 RR	'03 -'06	ESTR-0103	100,00
CBR 600 RR	'13 -'15	ESTR-0118	100,00
CROSSRUNNER 800 NEW	'15	/	/
HORNET 600 (8)	'11 -'13	ESTR-0110	140,00
HORNET 600 (9)	'11 -'13	ESTR-0113	70,00
INTEGRA / 750 (3)	'12 -'15	ESTR-0117	105,00
NC 700 X (3)	'12 -'14	ESTR-0117	105,00
NC 750 X (3)	'12 -'14	ESTR-0117	105,00
NUDA 900	'11 -'13	ESTR-1401	80,00
ER6F	'09 -'11	ESTR-0410	70,00
ER6N	'06 -'08	ESTR-0408	70,00
ER6N	'09 -'11	ESTR-0410	70,00
ER6N	'12 -'16	ESTR-0414	75,00
VERSYS 650	'10 -'14	ESTR-0412	75,00
VERSYS 650 NEW	'15 -'16	/	/
VERSYS 1000 (12)	'12 -'14	ESTR-0415	90,00
VERSYS 1000 NEW	'15 -'16	/	/
Z 250 NEW	'15	ESTR-0418	75,00
Z 300 NEW	'15 -'16	ESTR-0418	75,00
Z 750 / Z 750 R '11- (2)	'07 -'14	ESTR-0406	85,00
Z 1000 (2)	'07 -'09	ESTR-0406	85,00

EN

- (1) Do not include indicators light kit because the bike includes them on the tail
- (2) Includes some pieces machined from aluminium billet
- (3) Includes the rear led light
- (4) Different discount
- (5) Compatible with travel bags
- (6) Only for original exhaust
- (7) For aftermarket exhaust
- (8) Premium version (bracket machined from Alu.)
- (9) Eco version (sheet Alu.)
- (10) Optional Led Light
- (11) Led light is not necessary because already included in the rear light
- (12) While supplies last

DE

- (1) Dieser Kennzeichenhalter beinhaltet keine Blinkerhalter, da die Blinker im Heck montiert sind
- (2) Dieser Kennzeichenhalter beinhaltet gefräste Aluminiumteile aus Duraluminium
- (3) Dieser Kennzeichenhalter beinhaltet ein LED-Rücklicht
- (4) Sie sind mit anderen Rabatten belegt
- (5) Kompatibel mit Satteltaschen
- (6) Nur für Originalauspuff
- (7) Für Zubehörauspuff
- (8) Premium Version (Halter gefertigt aus Alu.)
- (9) Standard Version (Aluminiumblech)
- (10) Fakultativ Led Kennzeichenbeleuchtung
- (11) LED-Kennzeichenbeleuchtung ist nicht notwendig, da dieses bereits in der originalen Rückleuchte enthalten ist
- (12) Solange der Vorrat reicht



BRAND

KAWASAKI

KTM

MV AGUSTA

SUZUKI

TRIUMPH

MODEL	YEAR	CODE	EURO w/o tax
Z 1000	'10 -'13	ESTR-0411	70,00
Z 1000	'14 -'16	ESTR-0417	90,00
Z 1000 SX	'10 -'16	ESTR-0411	70,00
Z800 NEW	'13 -'16	ESTR-0416	80,00
Z800 E NEW	'13 -'16	ESTR-0416	80,00
ZX 6R (2)	'09 -'15	ESTR-0407	70,00
ZX 6R NEW	'13 -'15	ESTR-0407	70,00
ZX 10R (2)	'08 -'10	ESTR-0407	70,00
ZX 10R (1) (2)	'11 -'15	ESTR-0413	85,00
ZX 10R NEW	'16	/	/
ZX 636 NEW	'13 -'15	ESTR-0407	70,00
625 SMC	/	ESTR-0907	70,00
690 Duke	'08 -'11	ESTR-0901	70,00
690 Duke/R	'12 -'15	ESTR-0905	90,00
690 SMC/ENDURO/R	/	ESTR-0902	120,00
690 SUPERMOTO/R	/	ESTR-0901	70,00
990/950 SUPERMOTO/R/T	'09 -'14	ESTR-0904	90,00
1190 RC8/R	'08 -'15	ESTR-0903	70,00
1290 SUPERDUKE GT NEW	'16	/	/
1290 SUPERDUKE R NEW	'14 -'15	ESTR-0908	90,00
RC 125 NEW	'15	ESTR-0910	75,00
RC 200 NEW	'15	ESTR-0910	75,00
RC 390 NEW	'15	ESTR-0910	75,00
BRUTALE 675 / RR	'12 -'15	ESTR-0504	75,00
BRUTALE 800 / RR	'12 -'15	ESTR-0504	75,00
BRUTALE 800 NEW	'16	/	/
BRUTALE 1090	/	ESTR-0501	70,00
BRUTALE 1078	/	ESTR-0501	70,00
BRUTALE 910	/	ESTR-0501	70,00
F3	'12 -'15	ESTR-0503	75,00
F4	'10 -'12	ESTR-0502	77,00
F4	'13 -'15	ESTR-0505	80,00
DRAGSTER 800 NEW	'14 -'15	ESTR-0507	
RIVALE 800 NEW	'13 -'15	ESTR-0506	<i>MV AGUSTA EXCLUSIVE*</i>
STRADALE 800 NEW	'15	ESTR-0508	
GLADIUS (3)	/	ESTR-0313	135,00
GS R 750	'10 -'15	ESTR-0315	80,00
GSX-R 600/750 (1) (12)	'06 -'07	ESTR-0306	70,00
GSX-R 600/750 (1)	'08 -'10	ESTR-0309	70,00
GSX-R 600/750 (1)	'11 -'15	ESTR-0314	74,00
GSX-R 1000 (1) (12)	'05 -'08	ESTR-0305	70,00
GSX-R 1000	'09 -'15	ESTR-0312	70,00
GSX-R 1000 NEW	'16	/	/
GSX-S 1000 NEW	'15	ESTR-0316	80,00
GSX-S 1000 F NEW	'15	/	/
SV-650 NEW	'16	/	/
SV-650/S (12)	'03 -'08	ESTR-0311	70,00
BONNEVILLE NEW	'09 -'15	ESTR-0708	140,00
BONNEVILLE NEW	'16	/	/
DAYTONA 675/R	'06 -'12	ESTR-0702	70,00

ES

(1) No incluye kit soporte de intermitencia ya que se utilizan los alojados en el colín de la moto

(2) Incluye varias piezas mecanizadas

(3) Incluye piloto trasero de leds ref. ELT004

(4) Este soporte tiene un descuento diferente

(5) Compatible con maletas

(6) Para escape original

(7) Para escape aftermarket

(8) Versión Premium (soporte mecanizado)

(9) Versión ECO (placa aluminio)

(10) Luz de matrícula opcional

(11) Luz de matrícula no necesaria ya que se utiliza la original, situada en el colín de la moto

(12) Producto sujeto a disponibilidad

FR

(1) Les supports de clignotants ne sont pas fournis avec le support de plaque, ceux-ci étant intégrés dans les feux

(2) Les supports de plaque contiennent des éléments taillés masse

(3) Les supports de plaque contiennent le feu arrière ELT004

(4) Remise différent

(5) Compatible avec sacs de voyage

(6) Pour silencieux originaux

(7) Pour silencieux aftermarket

(8) Version Premium (taillé masse)

(9) Version Eco (magnésium pliés)

(10) Éclairage de plaque optionnel

(11) Pas besoin d'éclairage de plaque, déjà inclus dans le feu ar

(12) Jusqu'à épaisseur du stock

BRAND

TRIUMPH

YAMAHA

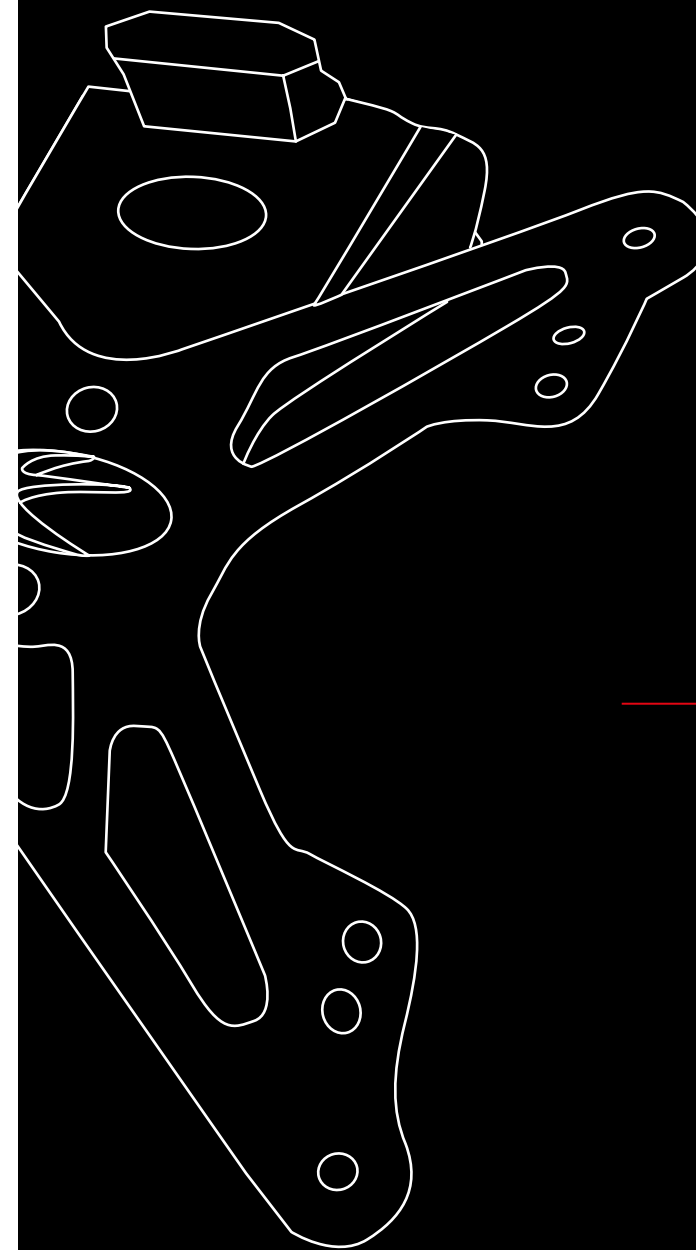

MODEL	YEAR	CODE	EURO w/o tax
DAYTONA 675/R (8)	'13 -'15	ESTR-0706	170,00
DAYTONA 675/R (9)	'13 -'15	ESTR-0707	80,00
SPEED TRIPLE	'06 -'07	ESTR-0701	70,00
SPEED TRIPLE	'08 -'10	ESTR-0704	149,00
SPEED TRIPLE/R	'11 -'15	ESTR-0705	85,00
SPEED TRIPLE S/R NEW	'16	/	/
STREET TRIPLE/R	'07 -'12	ESTR-0703	85,00
STREET TRIPLE RX (8)	'15	ESTR-0706	170,00
STREET TRIPLE RX	'15	ESTR-0707	80,00
STREET TRIPLE 675/R (8)	'13 -'15	ESTR-0706	170,00
STREET TRIPLE 675/R (9)	'13 -'15	ESTR-0707	80,00
SCRAMBLER	/	ESTR-0708	140,00
THRUXTON	/	ESTR-0708	140,00
FZ1/Fazer	'06 >	ESTR-0209	70,00
FZ6/Fazer (12)	'04 -'11	ESTR-0207	70,00
FZ8	'10 >	ESTR-0209	70,00
MT-03 NEW	'16	/	/
MT-07 NEW	'14 -'15	ESTR-0217	80,00
MT-09 NEW	'14 -'15	ESTR-0216	90,00
MT-10 NEW	'16	/	/
MT-125 NEW	'14 -'15	/	/
R1 (8)	'09 -'14	ESTR-0213	70,00
R1 (7)	'09 -'14	ESTR-0214	70,00
R1 NEW	'15 -'16	ESTR-0219	75,00
R3 NEW	'15	ESTR-0220	80,00
R6	'06 -'15	ESTR-0208	70,00
T-MAX	'08 -'11	ESTR-0210	125,00
T-MAX	'12 -'15	ESTR-0215	75,00
XJ6	'09 -'15	ESTR-0212	70,00
YZF-R 125	'08 -'13	ESTR-0211	70,00
YZF-R 125 NEW	'14 -'15	ESTR-0218	80,00

* Acquistabile solo sul catalogo MV AGUSTA / Available only in MV AGUSTA catalogue / Exklusiv MV AGUSTA Katalog / Disponible solo en el catálogo MV AGUSTA / Disponible uniquement sur le catalogue MV AGUSTA

**ACCESSORI PORTA TARGA / TAIL TIDY ACCESSORIES / KENNZEICHENHALTER ZUBEHÖR
PORTA MATRÍCULA Y ACCESORIOS / SUPPORT DE PLAQUE ET ACCESSOIRES**

DESCRIZIONE / DESCRIPCIÓN / DESCRIPTION	CODE	EURO w/o tax
Kit accessori targa / kit of plate's accessories / Kit von der Platte Accessories / kit accesorios matrícula / Kit accessoires de plaque *	KIT-ELT	34,00
Kit accessori targa / kit of plate's accessories / Kit von der Platte Accessories kit accesorios matrícula / Kit accessoires de plaque **	KIT-ELT-2	36,00

* Comprende luce targa,supporto catadiotro,catadiotro / It includes led light,rear reflector support,reflector lens / Es umfasst LED-Licht, Rückstrahler Unterstützung, Reflektor Linse / Incluye luz de matrícula, soporte de catadióptico, catadióptico / Inclut l'éclairage de plaque, le support réfléchissant et le catadioptr

** Comprende luce targa,supporto catadiotro (inclinazione 30°),catadiotro / It includes led light,rear reflector support (30°inclination),reflector lens / Es umfasst LED-Licht, Rückstrahler Unterstützung (30° Neigung), Reflektor Linse / Incluye luz de matrícula, soporte de catadióptico (30° de inclinacion), catadióptico / Inclut l'éclairage de plaque, le support réfléchissant (30° d'inclination) et le catadioptr

DESCRIZIONE / DESCRIPCIÓN / DESCRIPTION	CODE	EURO w/o tax
Luce targa a LED / LED light / LED Kennzeichenbeleuchtung Luz de matrícula / Éclairage de plaque **	ELT-001	25,00
Copriluce / Light covers / Deckel für Beleuchtung Tapa luz de matrícula/ Couvercle pour l'éclairage	EPR-S01-TP	3,00
Catarifrangente / Reflector lens / Reflektor Catadióptico / Catadioptr **	ELT-002	5,00
Supporto catarifrangente / Reflector support / Reflektorhalter Soporte de catadióptico / Support réfléchissant ***	ELT-005	7,00
Supporto catarifrangente / Reflector support / Reflektorhalter Soporte de catadióptico / Support réfléchissant	ELT-009	5,00
Supporto catarifrangente, inclinazione 30° / Reflector support / Reflektorhalter Soporte de catadióptico / Support réfléchissant	ELT-010	7,00
Fanale a LED posteriore / LED rear brake light / LED Rücklicht Luz trasera de leds / Feu arrière **	ELT-004	50,00
Fanale a LED posteriore / LED rear brake light / LED Rücklicht Luz trasera de leds / Feu arrière **	ELT-006-F	30,00
Fanale a LED posteriore / LED rear brake light / LED Rücklicht Luz trasera de leds / Feu arrière ⁽¹⁾	ELT-007	36,00

⁽¹⁾ Sconto differente

Different discount

Anderer Rabatt

Diferente descuento

Remise différent

** Omologata

Homologated

Homologierte

Homologado

Homologué

*** Personalizzabile

(solo per targhe italiane)



BRAND

KIT Aftermarket

APRILIA

BENELLI

BMW

DUCATI old models

DUCATI new models

HUSQVARNA old models

HUSQVARNA new models

HONDA

MV AGUSTA

KAWASAKI

KTM

SUZUKI

TRIUMPH old models

TRIUMPH new models

YAMAHA

FRECCE A LED / LED INDICATORS LIGHT / LED BLINKER / INTERMITENTES DE LED / CLIGNOTANTS LED

DESCRIZIONE / DESCRIPTION / BESCHREIBUNG	CODE	EURO w/o tax
Freccia Modello 1 / Model 1 / Modell 1 Intermitentes mod 1 / Clignotant modèle 1 *	F-01 **	30,00
Freccia Modello 2 / Model 2 / Modell 2 Intermitentes mod 2 / Clignotant modèle 2*	F-02 **	30,00
Freccia Modello Koso 4 / Model 4 / Modell 4 Intermitentes mod 4 / Clignotant modèle 4 *	F-04 °	55,00
Resistenza 6W / Resistor 6W / Vorwiderstände 6W Resistencias 6W / Résistances 6W*	RES-6W	22,00
Resistenza 10W / Resistor 10W / Vorwiderstände 10W Resistencias 10W / Résistances 10W*	RES-10W	15,00
Resistenza 21W / Resistor 21W / Vorwiderstände 21W Resistencias 21W / Résistances 21W*	RES-21W	26,00
Led flasher / Led flasher unit / LED Blinkrelais LED flasher / Flash-01	FLASH-01	15,00



* Coppia / Pair / Paar / Pareja / Paire

** Omologata / Homologated / Homologiert / Homologado / Homologué

* Sconto differente / Different discount / Anderer Rabatt / Diferente descuento / Remise différent

**SUPPORTO PER FRECCHE ORIGINALI / ORIGINAL INDICATORS SUPPORT / ADAPTER FÜR ORIGINALBLINKER
SOPORTE PARA INTERMITENTES ORIGINALES / SUPPORTS POUR CLIGNOTANTS D'ORIGINE**

MODEL	CODE	COLOUR	EURO w/o tax
Tutti / All / Alle / Todos / Tous	SFK-10	Dn	5,00
Tutti / All / Alle / Todos / Tous	SFO-10-A	Dn	6,50
TNT	SFO-06-A	Dn	6,50
BN 600	SFO-12-A	Dn	6,50
BN 302	SFO-06-B	Dn	6,50
Tutti / All / Alle / Todos / Tous	SFO-10-A	Dn	6,50
Tutti / All / Alle / Todos / Tous	SFO-10-A	Dn	6,50
Tutti / All / Alle / Todos / Tous	SFO-08-A	Dn	6,50
Tutti / All / Alle / Todos / Tous	SFO-08-A	Dn	6,50
Tutti / All / Alle / Todos / Tous	SFO-10-A	Dn	6,50
Tutti / All / Alle / Todos / Tous	SFO-01-A	Dn	6,50
Tutti / All / Alle / Todos / Tous	SFO-05-A	Dn	6,50
Tutti / All / Alle / Todos / Tous	SFO-04-A	Dn	6,50
Tutti / All / Alle / Todos / Tous	SFO-09-A	Dn	6,50
Tutti tranne / All Except / Alle außer Todos excepto / Sauf puor:	SFO-03-A	Dn	6,50
GSX-S 1000 '15	SFO-03-B	Dn	6,50
Tutti / All / Alle / Todos / Tous	SFO-10-A	Dn	6,50
Tutti / All / Alle / Todos / Tous	SFO-07-A	Dn	6,50
Tutti tranne / All Except / Alle außer Todos excepto / Sauf puor:	SFO-02-A	Dn	6,50
YZF - R125 '13-'14	SFO-09-A	Dn	6,50



* Coppia / Pair / Paar / Pareja / Paire

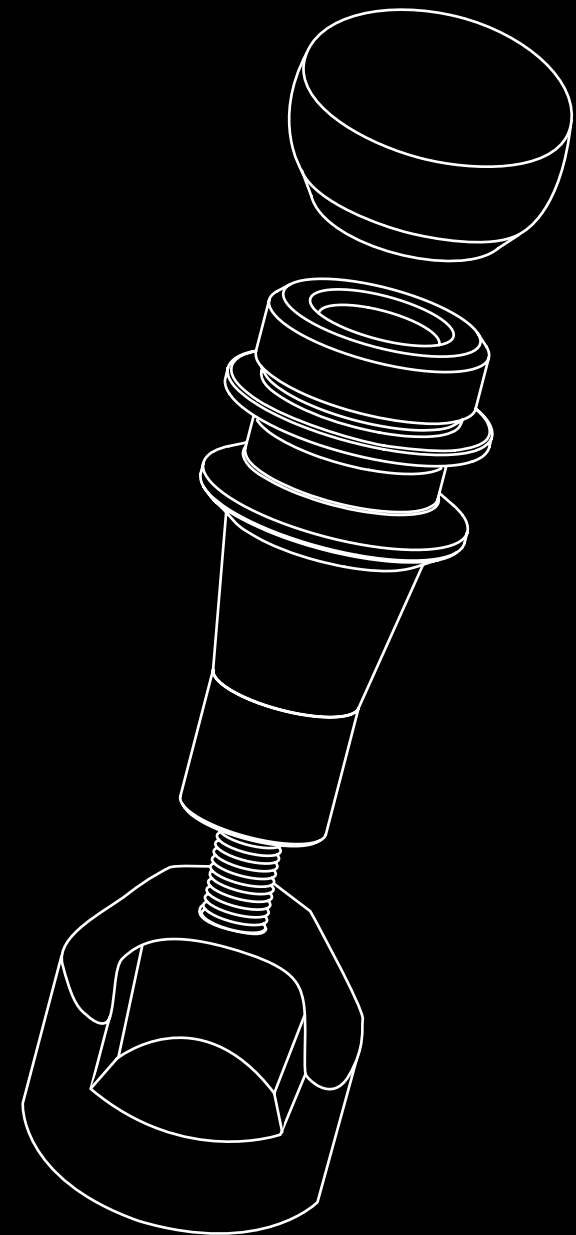

ADATTATORI FRECCHE AFTERMARKET / AFTERMARKET INDICATORS ADAPTERS / AFTERMARKET ADAPTER FÜR BLINKER SOPORTE INTERMITENTES AFTERMARKET / ADAPTATEUR CLIGNOTANTS AFTERMARKET

CODE	COLOUR	EURO w/o tax	
AFIL-01	Dn	12,00	
AFIL-02	Dn	12,00	
AFIL-03	Dn	12,00	
AFIL-04	Dn	12,00	
AFIL-05	Dn	12,00	
AFIL-06	Dn	12,00	
AFIL-07	Dn	12,00	
AFIL-08	Dn	12,00	
AFIL-09	Dn	12,00	
AFIL-10	Dn	12,00	
AFIL-11	Dn	12,00	

* Per applicazioni consultare il sito web / For application visit our website / Für Anbaumöglichkeiten besuchen Sie unsere Website / Visita nuestra web para comprobar su aplicación / Consulter le site pour voir les applications.

TAMPONI STREET DEFENDER / STREET DEFENDER FRAME SLIDERS / STREET DEFENDER STURZPAD PROTECTORES ANTICAIDA STREET DEFENDER / ROULETTE DE PROTECTION STREET DEFENDER

MODEL	YEAR	CODE	EURO w/o tax
RSV4 FACTORY	'09-'12	STD-V4	150,00
RSV4 FACTORY	'13-'15	STD-TUONO V4	150,00
RSV4 R	'09-'15	STD-V4	150,00
RSV4 / RF	'15-'16	STD-V4	150,00
TUONO R / FACTORY	'06-'11	STD-A01	100,00
TUONO V4	'11-'15	STD-TUONO V4	150,00
TUONO V4 1100 RR	'15-'16	STD-TUONO V4	150,00
S1000RR	'10-'15	STD-S1000RR ⁽¹⁾	120,00
MONSTER 696 *	/	STD-D1	179,00
MONSTER 796 *	/	STD-D1	179,00
MONSTER 1100 *	/	STD-D1	179,00
MONSTER 1100 EVO *	/	STD-D1	179,00
CBR 600 F	'11-'14	STD-H13	120,00
CBR 600 RR	'07-'08	STD-H06	120,00
CBR 600 RR NEW	'13	STD-H15	120,00
CBR 1000 RR	'05	STD-H10	120,00
CBR 1000 RR	'06-'07	STD-H11	120,00
CROSSRUNNER	'11-'14	STD-H14	100,00
ER6-N	'06-'08	STD-ER6	80,00
ER6-N	'09-'11	STD-ER6-2	70,00
ER6-N	'12-'16	STD-ER6-3	100,00
VERSYS 650	'07-'14	STD-ER6	80,00
Z750	'07-'14	STD-K12	90,00
Z800	'13-'16	STD-K14	92,00
Z1000	'07-'09	STD-K12	90,00
Z1000	'14-'16	STD-K15	160,00
Z1000 SX	'11-'13	STD-K13	160,00

⁽¹⁾ Lato dx viti OEM / OEM screws on the right side / Lado derecho tornilleria original / OEM Schrauben Recht / OEM vis sur le côté droit

* Sconto differente / Different discount / Anderer Rabatt / Diferente descuento / Remise différent

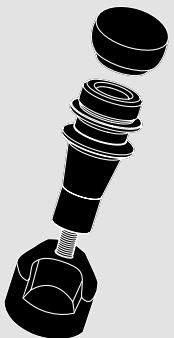

- BRAND
- APRILIA
- BMW
- DUCATI
- HONDA
- KAWASAKI



- BRAND
- KAWASAKI
- KTM
- SUZUKI
- TRIUMPH
- YAMAHA
- BRAND
- APRILIA
- BENELLI
- BMW
- HONDA

MODEL	YEAR	CODE	EURO w/o tax
ZX6R / RR	'05-'06	STD-K6	80,00
ZX6R	'07-'08	STD-K7	80,00
ZX6R	'09-'15	STD-K8	120,00
SUPERMOTO 990	'09-'14	STD-SM990	100,00
SUPERDUKE 990	'09-'11	STD-SDUKE	100,00
DUKE 125/200/390	/	STD-DK125	110,00
GSX-R 600 / 750	'06-'07	STD-GX	100,00
GSX-R 600 / 750	'08-'10	STD-GX2	100,00
GSX-R 600 / 750	'11-'15	STD-GX3	120,00
DAYTONA 675	'06-'12	STD-T675	150,00
STREET TRIPLE	'07-'12	STD-T675	150,00
STREET TRIPLE 675/R NEW	'13-'15	STD-ST TRIPLE	150,00
SPEED TRIPLE	'08-'10	STD-SPEED	100,00
TIGER 1050	'07-'12	STD-TIGER	150,00
R6	'03-'05	STD-Y6	80,00
R6	'06-'07	STD-Y6	100,00
R1	'07-'08	STD-Y9	100,00
R1*	'09-'14	STD-Y11	96,00
XJ6	'09-'15	STD-Y10	90,00
MT 07* NEW	'14-'15	STD-Y12	178,00

* Sconto differente / Different discount / Anderer Rabatt / Diferente descuento / Remise différent

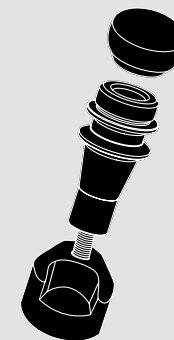

TAMPONI PARATELAIO DEFENDER / DEFENDER FRAME SLIDERS / DEFENDER STURZPAD PROTECTORES ANTICAIDA DEFENDER / ROULETTE DE PROTECTION DEFENDER

MODEL	YEAR	MODIFICATION	CODE	EURO w/o tax
DORSODURO	/		DEF1002	65,00
SHIVER	/		DEF1002	65,00
TnT 899	'05 >		DEF0601	60,00
TnT 900	'05 >		DEF0601	60,00
TnT 1130	'05 >		DEF0601	60,00
Tre 1130 K	'06 >		DEF0602	60,00
BN 600 NEW	'14		DEF0603	50,00
F800 R/S	'11-'15		DEF1103	50,00
S 1000 XR	'15		DEF1107	50,00
CB 1000 R	'08-'15		DEF0110	45,00
CBF 600/N	'04-'07		DEF0101	45,00
CBF 600 N/S	'08-'10		DEF0109	45,00
CBF 1000	'10-'13		DEF0109	45,00
CBF 1000 / ST	'06-'09		DEF0107	45,00
CBF 1000 / ST	'10		DEF0109	45,00
CBF 1000 / ST	'11		DEF0110	45,00
CBR 600 F	'11-'13	LX RX	DEF0113	45,00
CBR 600 F / SPORT	'99-'06	LX RX	DEF0102	45,00
CBR 600 RR	'03-'06	LX RX	DEF0103	45,00
CBR 600 RR	'07-'15	LX RX	DEF0108	45,00
CBR 900 RR	'00-'03		DEF0104	45,00
CBR 1000 RR	'04-'07	LX RX	DEF0106	45,00
CBR 1000 RR	'08-'15	LX RX	DEF0111	45,00





BRAND

HONDA

HUSQVARNA

KAWASAKI

MV AGUSTA

SUZUKI

MODEL	YEAR	MODIFICATION	CODE	EURO w/o tax
HORNET 600	'98 -'06		DEF0101	45,00
HORNET 600	'07 -'13		DEF0109	45,00
HORNET 900	'01 -'07		DEF0105	50,00
NUDA 900	'12 -'13		DEF1401	60,00
VERSYS 1000	'12 -'14		DEF0415	50,00
Z 750	'04 -'06		DEF0403	50,00
Z 750 / R	'07 -'14		DEF0406	50,00
Z 1000	'03 -'06		DEF0403	50,00
Z 1000	'07 -'09		DEF0406	50,00
Z 1000	'10 -'13		DEF0410	50,00
Z 1000 SX	'11 -'13	LX RX	DEF0411	50,00
Z 1000 SX	'14 -'16		/	/
ZX 6R/RR	'03 -'04		DEF0401	45,00
ZX 6R/RR	'05 -'06	LX	DEF0401	45,00
ZX 6R	'07 -'08		DEF0405	45,00
ZX 6R	'09 -'15	LX RX	DEF0409	45,00
ZX 9R	'02 -'04		DEF0404	45,00
ZX10R #	'04 -'05	LX RX	DEF0402	45,00
ZX10R **	'06 -'07	LX RX	DEF0402	45,00
ZX10R	'08 -'10	LX	DEF0407	45,00
ZX10R	'11 -'15		DEF0412	45,00
ZZR 1400	'07 -'16		DEF0408	50,00
BRUTALE 675	'12 -'15		DEF0504	80,00
BRUTALE 750	/		DEF0501	45,00
BRUTALE 800	'12 -'15		DEF0504	80,00
BRUTALE 910 R / S	/		DEF0501	45,00
BRUTALE 990 R	'10 -'14		DEF0502	50,00
BRUTALE 1078	/		DEF0501	45,00
BRUTALE 1090	'10 -'14		DEF0502	50,00
DRAGSTER 800 NEW	'14 -'15		DEF0504	80,00
F4 750	/	LX RX	DEF0501	45,00
F4 1000	/	LX RX	DEF0501	45,00
RIVALE 800 NEW	'13 -'15		DEF0504	80,00
B-KING	'08 -'14		DEF0310	45,00
GLADIUS	/		DEF0313	60,00
GSR 600	'06 -'14		DEF0307	45,00
GSR 750	'10 -'15		DEF0315	45,00
GSX-R 600 / 750	'97 -'99		DEF0301	45,00
GSX-R 600 / 750	'00 -'03	LX	DEF0301	45,00
GSX-R 600 / 750	'04 -'05		DEF0301	45,00
GSX-R 600 / 750	'06 -'10	LX	DEF0306	45,00
GSX-R 600 / 750	'11 -'15	LX RX	DEF0314	45,00
GSX-R 1000	'00 -'02	LX	DEF0301	45,00
GSX-R 1000	'03 -'04		DEF0301	45,00
GSX-R 1000	'05 -'06		DEF0305	45,00
GSX-R 1000	'07 -'08		DEF0308	45,00
GSX-R 1000	'09 -'11	LX RX	DEF0312	45,00
GSX-S 1000	'15		DEF0316	50,00
SV 650 NAKED / S	'00 -'02		DEF0304	50,00
SV 650 NAKED / S	'03 -'07		DEF0302	50,00
SV 650 NAKED / S	'08 -'11		DEF0311	50,00

BRAND

SUZUKI

TRIUMPH

YAMAHA

#

- IT Fino ad esaurimento scorte.
- ES Sujeto a disponibilidad
- FR Sous réserve de disponibilité
- EN Subject to availability
- DE Vorbehaltlich Verfügbarkeit

*

- IT È necessario sostituire il serbatoio del fluido radiatore
- EN It is necessary to replace the tank of radiator's fluid
- DE Zur Montage des Sturzpad muss der Ausgleichsbehälter der Wasserkühlung demontiert werden
- ES Es necesario reemplazar el depósito de líquido sobrante del radiador
- FR Il est nécessaire de remplacer le réservoir de liquide de radiateur

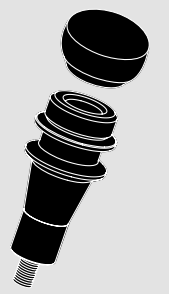

BRAND

SUZUKI

TRIUMPH

YAMAHA

MODEL	YEAR	MODIFICATION	CODE	EURO w/o tax
SV 1000	'03 -'06		DEF0303	50,00
Daytona	'99 -'04		DEF0701	50,00
Speed Triple	'99 -'07		DEF0701	50,00
Speed Triple / R	'11 -'15		DEF0705	50,00
Street Triple	'07 -'12		DEF0702	50,00
FZ1 / FAZER	'06 -'15		DEF0209	45,00
FZ6 / FAZER	'04 -'11		DEF0207	45,00
FZ8	'06 -'15		DEF0209	45,00
MT-09/TRACER	'14 -'15		DEF0216	45,00
R1	'02 -'03		DEF0203	45,00
R1	'04 -'06		DEF0204	45,00
R1	'15 -'16		DEF0219	50,00
R3	'15		DEF0220	50,00
R6	'99 -'02	LX RX	DEF0205	45,00
R6	'03 -'05		DEF0206	45,00
R6	'06 -'07	LX	DEF0208	45,00
R6	'08 -'15		DEF0210	45,00
S2	'04 -'11		DEF0207	45,00
XJ6	'09 -'15	LX RX	DEF0212	45,00

BRAND

SUZUKI

TRIUMPH

YAMAHA

#

- IT Fino ad esaurimento scorte.
- ES Sujeto a disponibilidad
- FR Sous réserve de disponibilité
- EN Subject to availability
- DE Vorbehaltlich Verfügbarkeit

*

- IT È necessario sostituire il serbatoio del fluido radiatore
- EN It is necessary to replace the tank of radiator's fluid
- DE Zur Montage des Sturzpad muss der Ausgleichsbehälter der Wasserkühlung demontiert werden
- ES Es necesario reemplazar el depósito de líquido sobrante del radiador
- FR Il est nécessaire de remplacer le réservoir de liquide de radiateur

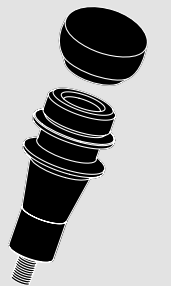

**TAPPI PER CINGHIE / ALUMINIUM PLUGS / ALUMINIUM ÖSENSCHRAUBEN
ENGANCHES CINCHA / BOUCHONS POUR SANGLES**

CODE	EURO w/o tax
DEF0005	36,00



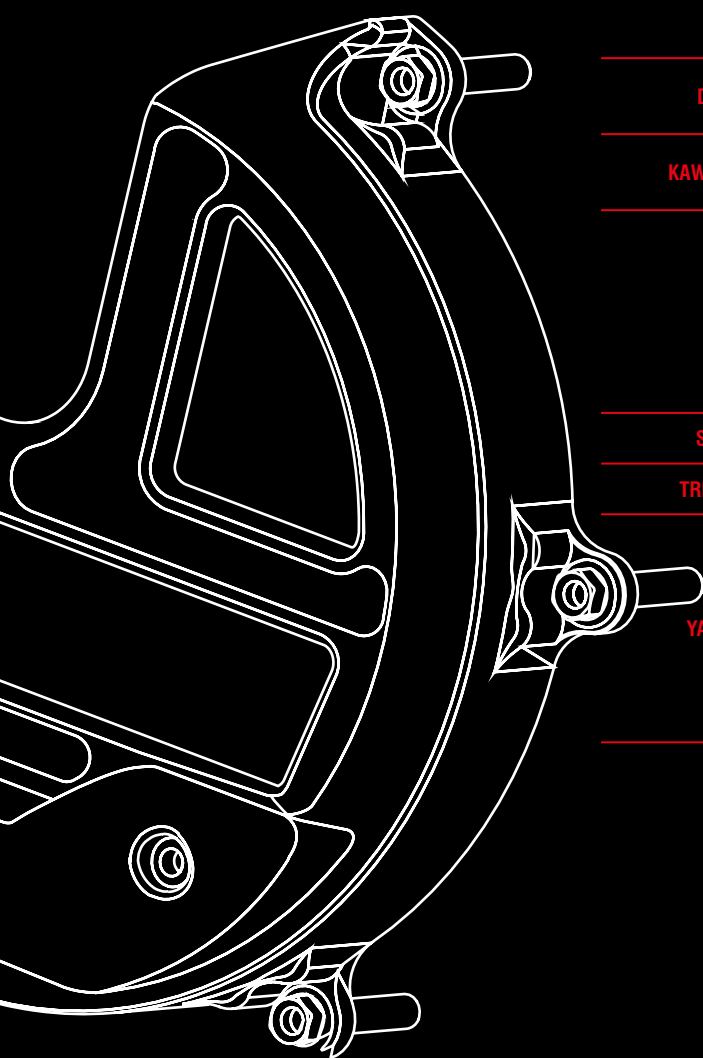

PROTEZIONI MOTORE / ENGINE PROTECTOR / MOTORSCHÜTZER / PROTECTORES MOTOR / PROTECTIONS MOTEUR

BRAND	MODEL	CODE	APPLICATION	COLOUR	EURO w/o tax
BENELLI	TNT	PRO-0601 (1) *	Clutch Protector	Si Dn / / / Cr / / / / /	270,00
	S 1000 R '15	PRO-1102-A PRO-1102-B (1) *	Protector RX	Si Dn / / / Rg Cr Eb / / / / /	80,00
	S 1000 RR '10 -'14		Protector LX	Si Dn / / / Cr Eb / / / / /	200,00
	S 1000 RR '15				
	S 1000 XR '15				
BMW	MONSTER 1100	PRO-0806-B (1) *	Protector LX	Si Dn / / / Cr / / / / /	/
	PANIGALE 1199	PRO-0811-A (1) *	Protector RX	Si Dn / / / Cr / / / / /	220,00
	PANIGALE 1199 / 1299	PRO-0811-B (1) *	Protector LX	Si Dn / / / Cr / / / / /	215,00
KAWASAKI	ZX6R '09-'15	PRO-0469-A PRO-0469-B PRO-0469-C		/ Dn / / / / / / / / /	80,00
				Si Dn / / / Rg / / / / / / /	100,00
				/ Dn / / / / / / / / /	150,00
				/ Dn / / / Cr / / / / /	160,00
				/ Dn / / / Cr / / / / /	160,00
SUZUKI	BRUTALE 675 NEW BRUTALE 800 NEW DRAGSTER NEW RIVALE 800 NEW F3	PRO-0504-A (1) * PRO-0504-B *	Protector RX Protector LX	/ Dn / / / Cr / / / / / / Dn / / / Cr / / / / /	160,00 160,00
				/ Dn / / / Cr / / / / /	160,00
				/ Dn / / / Cr / / / / /	160,00
				/ Dn / / / Cr / / / / /	90,00
TRIUMPH	BRUTALE 1078 NEW	PRO-0501-A PRO-0501-B	Protector RX Protector LX	/ Dn / / / Cr / / / / / / Dn / / / Cr / / / / /	/
YAMAHA	GSX-S 1000 R '15	PRO-0316-A PRO-0316-B	Protector RX Protector LX	Si Dn Ti Rg Cr Eb / / / / / Si Dn Ti Rg Cr Eb / / / / /	60,00 100,00
	STREET TRIPLE 675/R DAYTONA 675/R	PRO-0706-A (1) * PRO-0706-B *	Protector RX Protector LX	Si Dn Ti Rg Cr Eb / / / / / Si Dn Ti Rg Cr Eb / / / / /	140,00
YAMAHA	R1 '04-'06 R6 '06-'15	PRO-0204 (1) PRO-0210		/ Dn / / / / / / / / / / Dn / / / / / / / / /	36,00 40,00
	R1 '15	PRO-0219-A PRO-0219-B PRO-0219-C	Clutch Protector Protector LX Protector RX	Si Dn Ti Rg Cr Eb / / / / / Si Dn Ti Rg Cr Eb / / / / / Si Dn Ti Rg Cr Eb / / / / /	130,00 105,00 85,00
	R3 '15	PRO-0220-A PRO-0220-B	Protector LX Protector RX	Si Dn Ti Rg Cr Eb / / / / / Si Dn Ti Rg Cr Eb / / / / /	/

(1) Per i ricambi delle Sliders Protector consultare il sito web / For spare parts of Sliders Protector consult the web site
Um Einzelteile der Frame Sliders einzeln zu bestellen, besuchen Sie bitte unsere website / Para pedir recambio de nuestros protectores motor visite nuestra web / Pour les pièces de rechange de protections moteur visitez notre site web

IT Altri colori su richiesta
EN Other colors on request
DE Andere Farben auf Anfrage
ES Otros colores bajo pedido
FR Autres couleurs sur demande

* Sconto differente / Different discount / Anderer Rabatt / Diferente descuento / Remise différent

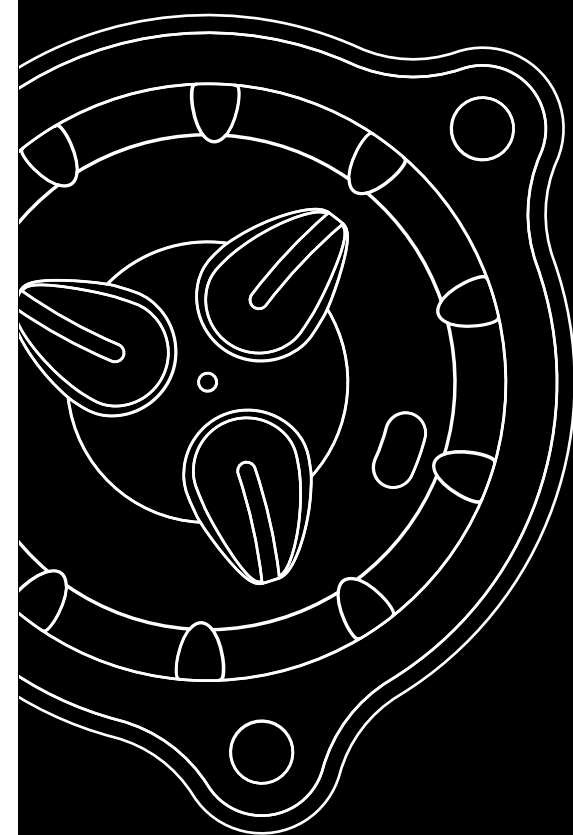
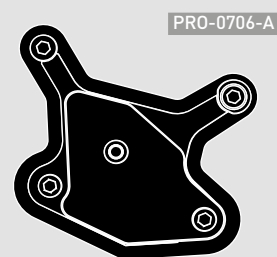

**COVER CARTER MOTORE T-MAX / T-MAX ENGINE SIDE COVER / T-MAX KUPPLUNGSGEHAUSEDECKEL
TAPA MOTOR T-MAX / COUVERCLE LATERAL DU MOTEUR T-MAX**

BRAND	MODEL	CODE	COLOUR	EURO w/o tax
YAMAHA	T-MAX '08-'15	CP-TM2 *	Si Dn TI Rg Cr EB	62,00
	T-MAX '12-'15	CP-TM3 *	Si Dn TI Rg Cr EB	45,00



CP-TM2

* singolo / single / einzel / individual / individuel



CP-TM3

**COVER RADIATORE / RADIATOR GUARD / KÜHLERSCHUTZ
PROTECTOR DE RADIADOR / GRILLE PROTECTION RADIATEUR**

BRAND	MODEL	CODE	COLOUR	EURO w/o tax
DUCATI	PANIGALE 1199/899	RADP-0811	Si / / / / / / / / /	75,00

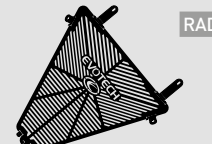

RADP-0811

**PROTEZIONI POMPA ACQUA / WATER PUMP COVER / WASSERPUMPEN-ABDECKUNG
PROTECTOR BOMBA AGUA / PROTECTION POMPE À EAU**

BRAND	MODEL	CODE	APPLICATION	COLOUR	EURO w/o tax
DUCATI	Diavel Monster 821 Monster 1200 MULTISTRADA 1200 '15	PRO-0813*	Water Pump Cover	Si Dn / / / Cr / /	170,00
	STREETFIGHTER 1098/1198 HYPERSTRADA 1198 / 1098 / 848 / 749/ 748 999 / 998 / 996 / 916 / RS HYPERMOTARD SP1 '13 -'15 MONSTER S4/R	PRO-0812*	Water Pump Cover	Si Dn / / / Cr / /	80,00



PRO-0812

IT Altri colori su richiesta
EN Other colors on request
DE Andere Farben auf Anfrage
ES Otros colores bajo pedido
FR Autres couleurs sur demande

* Sconto differente / Different discount / Anderer Rabatt / Diferente descuento / Remise différent

PROTEZIONI FORCELLE ANTERIORI / FRONT FORK GUARDS
PROTECTORES DE HORQUILLAS

MODEL	CODE	APPLICATION	COLOUR	EURO w/o tax
TUONO V4 1100 RR '15	PRFA-1005 ⁽¹⁾ *	Fork Protector	St Dn Ti Rg Cr Eb	35,00
BN 600	PRFA-0603 ⁽¹⁾ *	Fork Protector	St Dn Ti Rg Cr Eb	35,00
R 1200GS / R NINE T '14	PRFA-1105 ⁽¹⁾ *	Fork Protector	St Dn Ti Rg Cr Eb	35,00
S 1000 R '15	PRFA-1102 ⁽¹⁾ *	Fork Protector	St Dn Ti Rg Cr Eb	35,00
S 1000 XR	PRFA-1107 ⁽¹⁾ *	Fork Protector	St Dn Ti Rg Cr Eb	35,00
MONSTER 1200 '14	PRFA-0813 ⁽¹⁾ *	Fork Protector	St Dn Ti Rg Cr Eb	35,00
MONSTER 831	PRFA-0813 ⁽¹⁾ *	Fork Protector	St Dn Ti Rg Cr Eb	35,00
MONSTER 821	PRFA-0815 ⁽¹⁾ *	Fork Protector	St Dn Ti Rg Cr Eb	35,00
MULTISTRADA '15	PRFA-0814 ⁽¹⁾ *	Fork Protector	St Dn Ti Rg Cr Eb	35,00
SCRAMBLER '15	PRFA-0816 ⁽¹⁾ *	Fork Protector	St Dn Ti Rg Cr Eb	35,00
SMR 850 '06	PRFA-0904 ⁽¹⁾ *	Fork Protector	St Dn Ti Rg Cr Eb	35,00
BRUTALE 1078 '14	PRFA-0501 ⁽¹⁾ *	Fork Protector	St Dn Ti Rg Cr Eb	35,00
DRAGSTER 800 '15	PRFA-0507 ⁽¹⁾ *	Fork Protector	St Dn Ti Rg Cr Eb	35,00
GSX S1000 '15	PRFA-0316 ⁽¹⁾ *	Fork Protector	St Dn Ti Rg Cr Eb	35,00
R1 '15	PRFA-0219 ⁽¹⁾ *	Fork Protector	St Dn Ti Rg Cr Eb	35,00

PROTEZIONI FORCELLE POSTERIORI / REAR FORK GUARDS
PROTECTORES DE BASCULANTE

MODEL	CODE	APPLICATION	COLOUR	EURO w/o tax
R 1200GS / R NINE T '14	PRF-1104 ⁽¹⁾ *	Fork Protector	St Dn Ti Rg Cr Eb	100,00
S 1000 R '15	PRF-1102 ⁽¹⁾ *	Fork Protector	St Dn Ti Rg Cr Eb	35,00
S 1000 XR '15	PRF-1107 ⁽¹⁾ *	Fork Protector	St Dn Ti Rg Cr Eb	35,00
MONSTER 821	PRF-0815 ⁽¹⁾ *	Fork Protector	St Dn Ti Rg Cr Eb	35,00
SCRAMBLER '15	PRF-0816 ⁽¹⁾ *	Fork Protector	St Dn Ti Rg Cr Eb	35,00
950 SMR '06	PRF-0904 ⁽¹⁾ *	Fork Protector	St Dn Ti Rg Cr Eb	35,00
GSX S1000 '15	PRF-0316 ⁽¹⁾ *	Fork Protector	St Dn Ti Rg Cr Eb	35,00

⁽¹⁾ Per i ricambi delle Sliders Protector consultare il sito web / For spare parts of Sliders Protector refers to the web site

Um Einzelteile der Frame Sliders einzeln zu bestellen, besuchen Sie bitte unsere website / Para pedir recambio de nuestros protectores

motor visite nuestra web / Pour les pièces de rechange de protections moteur visitez notre site web

IT Altri colori su richiesta

EN Other colors on request

DE Andere Farben auf Anfrage

ES Otros colores bajo pedido

FR Autres couleurs sur demande

* Sconto differente / Different discount / Anderer

Rabatt / Diferente descuento / Remise différent

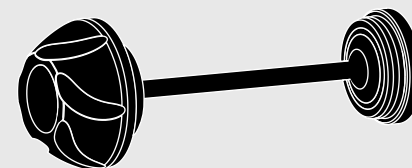

PRF-1104

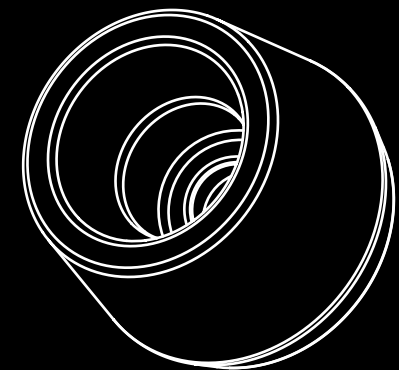

BRAND
APRILIA
BENELLI
BMW
DUCATI
KTM
MV AGUSTA
SUZUKI
YAMAHA

BRAND
BMW
DUCATI
KTM
SUZUKI

BRAND
YAMAHA

BRAND
BENELLI
TRIUMPH

BRAND
UNIVERSAL

COVER PERNO RUOTA / WHEEL COVER / TACHSABDECKUNGEN / CONO EJE TRASERO / CACHE AXE ROUE

MODEL	CODE	COLOUR	EURO w/o tax
T-MAX '01-'07	CPR-TM1	/ Dn / Rg Cr EB	62,00
T-MAX '08-'11	CPR-TM2	St Dn / Rg Cr EB	105,00

CPR-TM1



CPR-TM2

COPRI PIGNONE / PIGNON COVER / SCHUTZ FÜR ANTRIEBSRITZEL / PROTECTOR PIÑÓN / COUVERCLE DE PIGNON

MODEL	CODE	COLOUR	EURO w/o tax
TNT / TREK NEW	CPN-0601 *	St Dn / / Cr / / /	130,00
Bonneville	CPN-0708 *	St Dn / / / / / /	/

IT Altri colori su richiesta

EN Other colors on request

DE Andere Farben auf Anfrage

ES Otros colores bajo pedido

FR Autres couleurs sur demande

* Sconto differente / Different discount / Anderer

Rabatt / Diferente descuento / Remise différent

CPN-0601



PROTEZIONE STRUMENTAZIONE MOTECH / PROTECTION CASE MOTECH EQUIPMENT
CARCASA PROTECTORA CUADRO INSTRUMENTOS MOTECH / PROTECTION INSTRUMENTATION MOTECH

MODEL	CODE	COLOUR	EURO w/o tax
TUTTI/ALL/ALLE/TODOS/TOUS	DL-PROTECTOR-FRONT	/ / / / / / / Dks	150,00

⁽¹⁾ La cornice può essere personalizzata con il nome del vostro TIM /

The frame could be personalized with your name by laser engraving /

La pieza puede ser personalizada con el nombre del vostro team

Le cadre peut être personnalisé avec le nom de votre équipe

LEVA FRENO STAZIONAMENTO / PARKING BRAKE LEVER / HANDBREMSHEBEL
LEVA FRENO APARCAMIENTO / LEVIER DU FREIN DE PARKING

BRAND	MODEL	CODE	COLOUR	EURO w/o tax
YAMAHA	T-MAX '08-'15	LFM-TM2	St Dn TI Rg Cr EB	89,00



PIASTRA DI STERZO / TOP YOKE / GABELBRÜCKE / TIJA / COLONNE DE DIRECTION

BRAND	MODEL	CODE	COLOUR	EURO w/o tax
BENELLI	TNT	PSTR-0601 *	St Dn Cr	380,00
DUCATI	PANIGALE 1199 S '12 (Öhlins Forks) NEW	PSTR-0811 *	/ Dn Cr	380,00
TRIUMPH	STREET TRIPLE 675/R '13-'15 NEW	PSTR-0706 *	/ Dn Cr	/
	SPEED TRIPLE '11 -'15 NEW	PSTR-0705 *	/ Dn Cr	380,00



IT Altri colori su richiesta * Sconto differente / Different discount / Anderer
EN Other colors on request * Rabatt / Diferente descuento / Remise différent
DE Andere Farben auf Anfrage
ES Otros colores bajo pedido
FR Autres couleurs sur demande

TAPPO LIQUIDO FRENO / BRAKE FLUID CAP / DECKEL FÜR BREMSFLÜSSIGKEITSBEHÄLTER
TAPAS DEPÓSITO LÍQUIDO FRENO / COUVERCLE RESERVOIRE FREIN

BRAND	MODEL	CODE	COLOUR	EURO w/o tax
APRILIA	TUONO V4 1100 RR '15	TLI-04 ⁽¹⁾	St Dn Ti Rg Cr Eb /	60,00
BMW	R 1200 GS / R NINE T / R 1200 R	TLI-32 ⁽²⁾	St Dn Ti Rg Cr Eb /	58,00
DUCATI	DIAVEL	TLI-29 ⁽¹⁾	St Dn Ti Rg Cr Eb /	60,00
	DIAVEL	TLI-30 ⁽³⁾	St Dn Ti Rg Cr Eb /	58,00
	DIAVEL	TLI-33 ⁽¹⁾	St Dn Ti Rg Cr Eb /	/
	DIAVEL	TLI-34 ⁽³⁾	St Dn Ti Rg Cr Eb /	/
	MONSTER 1100 '10	TLI-04 ⁽¹⁾	St Dn Ti Rg Cr Eb /	45,00
	MONSTER 1100 EVO '10	TLI-04 ⁽¹⁾	St Dn Ti Rg Cr Eb /	45,00
	MONSTER 1200	TLI-04 ⁽¹⁾	St Dn Ti Rg Cr Eb /	45,00
	HYPERMOTARD	TLI-04 ⁽¹⁾	St Dn Ti Rg Cr Eb /	45,00
	848 / 1198 / 1098	TLI-04 ⁽¹⁾	St Dn Ti Rg Cr Eb /	45,00
	PANIGALE 1299 / 1199 / 899	TLI-04 ⁽¹⁾	St Dn Ti Rg Cr Eb /	45,00
HONDA	Crossrunner '11 >	TLI-17 ⁽¹⁾⁽³⁾	St Dn Ti Rg Cr Eb /	45,00
	Hornet 600 '11 >	TLI-17 ⁽¹⁾	St Dn Ti Rg Cr Eb /	45,00
	CBF600 '11 >	TLI-17 ⁽¹⁾	St Dn Ti Rg Cr Eb /	45,00
	NC700X	TLI-17 ⁽¹⁾	St Dn Ti Rg Cr Eb /	45,00
	CB 650 F '14 >	TLI-17 ⁽¹⁾	St Dn Ti Rg Cr Eb /	45,00
	Integra	TLI-17 ⁽¹⁾⁽²⁾	St Dn Ti Rg Cr Eb /	45,00
KAWASAKI	ER6N '09-'16	TLI-13 ⁽¹⁾	St Dn Ti Rg Cr Eb Gr	45,00
MV AGUSTA	Z800 '13-'16	TLI-13 ⁽¹⁾	St Dn Ti Rg Cr Eb Gr	45,00
YAMAHA	BRUTALE 1090	TLI-03	St Dn Ti Rg Cr Eb /	/
	T-MAX '04-'15	TLI-12 ⁽¹⁾⁽²⁾	St Dn Ti Rg Cr Eb /	45,00

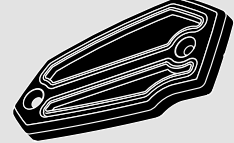

⁽¹⁾ Freno Anteriore / Front brake / Vorderradbremse
Freno Delantero / Frein Avant
⁽²⁾ Freno Posteriore / Rear brake / Hintere Bremse
Freno Trasero / Frein Arrière
⁽³⁾ Frizione / Clutch / Kupplung
Embrague / Embrayage

SERBATOIO FLUIDO / FLUID TANK / BREMSFLÜSSIGKEITSBEHÄLTER / DEPÓSITO FLUIDOS / RÉSERVOIRS DE FLUIDE

APPLICATION	CODE	COLOUR	EURO w/o tax
Freno posteriore / Frizione idraulica Rear brake / Hydraulic clutch Hintere Bremse / Hydraulische Kupplung Freno trasero / Embrague Frein arrière / Embrayage	RT-01-A	St Dn Ti Rg Cr Eb / Gr Dks	35,00
	RT-01-C	St Dn Ti Rg Cr Eb Or / Dks	
	RTB-UP1	St Dn Ti Rg Cr Eb / Gr Dks	

RT-01

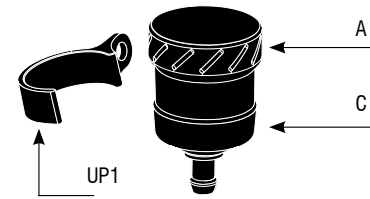

RT-02

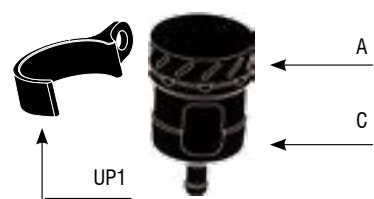

APPLICATION	CODE	COLOUR	EURO w/o tax
Freno posteriore / Frizione idraulica Rear brake / Hydraulic clutch Hintere Bremse / Hydraulische Kupplung Freno trasero / Embrague Frein arrière / Embrayage	RT-01-A	St Dn Ti Rg Cr Eb / Gr Dks	45,00
	RT-02-C	St Dn Ti Rg Cr Eb Or / Dks	
	RTB-UP1	St Dn Ti Rg Cr Eb / / Dks	

APPLICATION	CODE	COLOUR	EURO w/o tax
Freno anteriore Front brake Vorderradbremse Freno delantero Frein avant	RT-05-A	St Dn Ti Rg Cr Eb / Gr Dks	55,00
	RT-04-C	St Dn Ti Rg Cr Eb Or / Dks	

RT-04

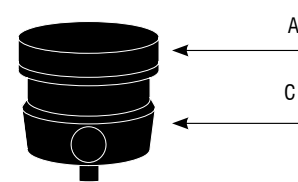

RT-05

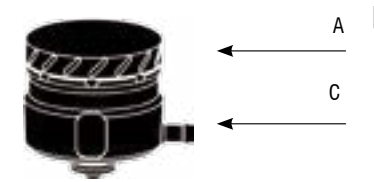

APPLICATION	CODE	COLOUR	EURO w/o tax
Freno anteriore Front brake Vorderradbremse Freno delantero Frein avant	RT-05-A	St Dn Ti Rg Cr Eb / Gr Dks	65,00
	RT-05-C	St Dn Ti Rg Cr Eb Or / Dks	

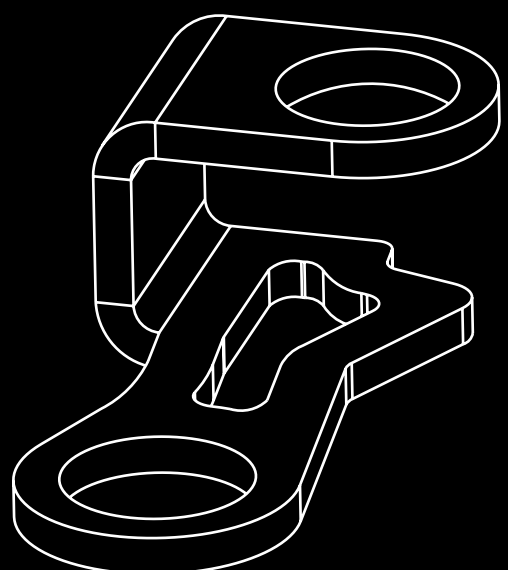
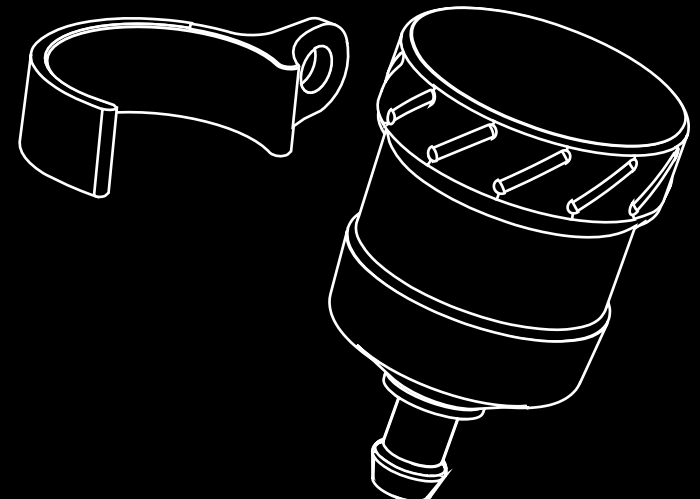

- BRAND**
- DUCATI**
- MV AGUSTA**
- YAMAHA**

STAFFE SUPPORTO SERBATOIO FLUIDO / ADAPTATION BRACKET FOR FLUID TANK / HALTERUNG BREMSFLÜSSIGKEITSBEHÄLTER PLETINA SUJECIÓN DEPÓSITO DE LÍQUIDO DE FRENO/EMBRAGUE / SUPPORT DE RÉSERVOIR DE FLUIDE

MODEL	APPLICATION	CODE	EURO w/o tax
PANIGALE 1199 S	Bracciale Frizione / Clutch's bracket / Kupplung Halterung Pletina sujeción depósito líquido embrague / Support embrayage	RT-UP6 *	Dks 13,00
	Bracciale Freno Anteriore / Clutch's bracket / Kupplung Halterung Pletina sujeción depósito líquido freno delantero / Support pour le frein avant	RT-UP7 *	Dks 13,00
MULTISTRADA 1200	Bracciale Frizione / Clutch's bracket / Kupplung Halterung Pletina sujeción depósito líquido embrague / Support embrayage	RT-UP9 *	Dks 13,00
	Bracciale Freno Anteriore / Front brake bracket / Vorderradbremse Halterung Pletina sujeción depósito líquido freno delantero / Support pour le frein avant	RT-UP10 *	Dks 13,00
F3	Bracciale Freno Anteriore / Front brake bracket / Vorderradbremse Halterung Pletina sujeción depósito líquido freno delantero / Support pour le frein avan	RT-UP12 *	Dks 13,00
BRUTALE 675/800 NEW	Bracciale Freno Posteriore / Rear bracket / Hintere Bremse Halterung Pletina sujeción depósito líquido freno trasero / Support pour le frein arrière	RT-U13 *	Dks 14,00
DRAGSTER / RIVALE NEW	Bracciale Freno Posteriore / Rear bracket / Hintere Bremse Halterung Pletina sujeción depósito líquido freno trasero / Support pour le frein arrière	RT-U13 *	Dks 14,00
R1 '15	Bracciale Freno Anteriore / Front brake bracket / Vorderradbremse Halterung Pletina sujeción depósito líquido freno delantero / Support pour le frein avant	RT-UP12 *	Dks 13,00

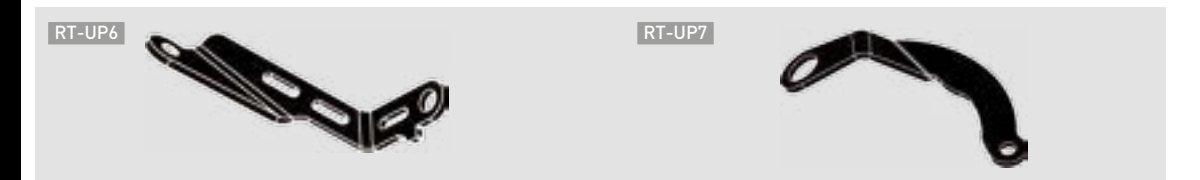

* Compatibile solo con serbatoio fluido Evotech / Brackets suitable only for Evotech fluid tanks / Halterungen eignen sich nur für Evotech Bremsflüssigkeitsbehälter / Sólo es compatible con depósito de líquido Evotech / Le Supports sont compatible seulement avec les réservoirs Evotech

TAPPI SPECCHIO / MIRROR HOLE CAPS / SPIEGEL TEILE / TAPAS PAR RETROVISORES / PLAQUES POUR RETROVISEURS

BRAND	MODEL	YEAR	CODE	COLOUR	EURO w/o tax
APRILIA	RSV4 FACTORY/R	/	GW-V4	St Dn Ti / Cr /	28,00
	S1000RR	'09-'15	GW-YA3	St Dn Ti Rg Cr Eb	28,00
BMW	PANIGALE 1299/1199/899	/	GW-DU1	St Dn Ti / Cr /	50,00
DUCATI	CBR 600 F	'99-'06	GW-HO	/ Dn / Rg Cr Eb	28,00
	CBR 600 F	'11-'13	GW-HO	/ Dn / Rg Cr Eb	28,00
	CBR 600 RR	'03-'15	GW-HO	/ Dn / Rg Cr Eb	28,00
	CBR 929 RR	'00-'01	GW-HO	/ Dn / Rg Cr Eb	28,00
	CBR 954 RR	'02-'03	GW-HO	/ Dn / Rg Cr Eb	28,00
	CBR 1000 RR	'04-'07	GW-HO	/ Dn / Rg Cr Eb	28,00
	HORNET 600 S	'98-'06	GW-HO	/ Dn / Rg Cr Eb	28,00
	VTR SP 1/2	/	GW-HO	/ Dn / Rg Cr Eb	28,00
	ER6-F	'06-'08	GW-KA1	/ Dn / Rg Cr /	28,00
	ZX 6R/RR	'03-'04	GW-KA1	/ Dn / Rg Cr /	28,00
KAWASAKI	Z 1000 SX	'11-'16	GW-KA4	St Dn Ti Rg Cr /	28,00
	ZX 6R	'09-'15	GW-KA3	/ Dn / Rg Cr /	28,00
	ZX 6R/RR	'05-'08	GW-KA2	/ Dn / Rg Cr /	28,00
	ZX 10R	'04-'10	GW-KA2	/ Dn / Rg Cr /	28,00
	ZX 10R	'11-'15	GW-KA5	St Dn Ti Rg Cr /	28,00
	F3	'12 >	GW-F3	St Dn / Rg Cr /	55,00
	GSX-R 600/750	'00-'05	GW-SU	/ Dn / Rg Cr Eb	28,00
	GSX-R 600/750	'06-'15	GW-S2	St Dn Ti Rg Cr Eb	28,00
	GSX-R 1000	'00-'04	GW-SU	/ Dn / Rg Cr Eb	28,00
	GSX-R 1000	'05-'15	GW-S2	St Dn Ti Rg Cr Eb	28,00
MV AGUSTA	SV 650 / S	'00-'09	GW-SU	/ Dn / Rg Cr Eb	28,00
	SV 1000 / S	'03-'08	GW-SU	/ Dn / Rg Cr Eb	28,00
	Daytona 675/R	'13-'15	GW-TR1	St Dn Ti Rg Cr Eb	50,00
	R1	'98-'06	GW-YA	St Dn Ti Rg Cr Eb	28,00
SUZUKI	R1	'07-'08	GW-KA1	/ Dn / Rg Cr /	28,00
	R1	'09-'14	GW-YA3	St Dn Ti Rg Cr Eb	28,00
	R1	'15-'16	GW-YA	St Dn Ti Rg Cr Eb	28,00
	R6	'99-'07	GW-YA	St Dn Ti Rg Cr Eb	28,00
	R6	'08-'15	GW-YA2	/ Dn / Rg Cr Eb	28,00
	FAZER 1000	'02-'03	GW-YA	St Dn Ti Rg Cr Eb	28,00
	T-MAX	'07	GW-MAX	St Dn Ti / Cr /	45,00
	T-MAX	'08-'11	GW-MAX2	/ Dn / / Cr /	65,00
	T-MAX 530	'12-'15	GW-MAX3	St Dn Ti Rg Cr /	65,00
	YZF-R 125	'14-'16	GW-HO	/ Dn / Rg Cr Eb	28,00

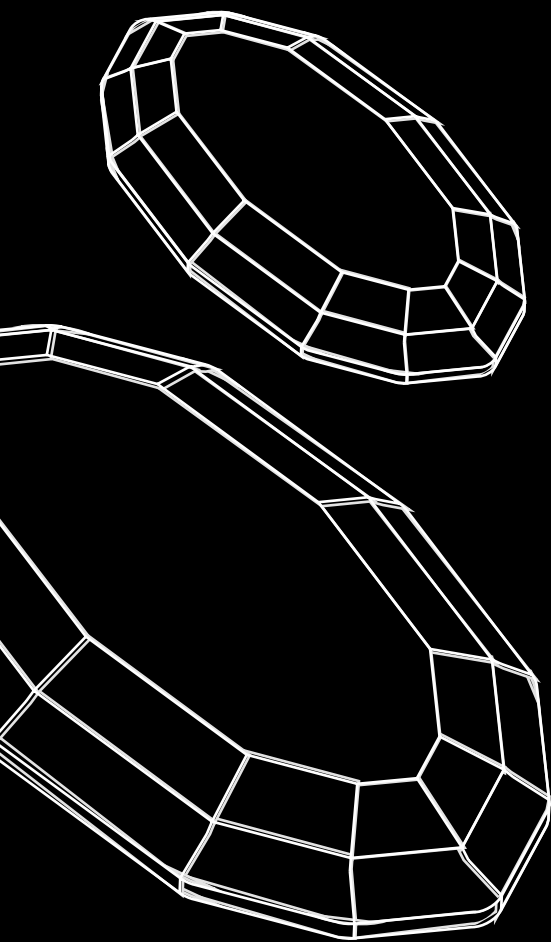
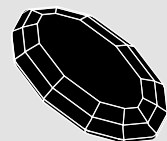

MANUBRI / HANDLEBAR / LENKER / MANILLARES / GUIDON

BRAND	CODE	COLOUR	EURO w/o tax
UNIVERSAL	MT 120 N25 750	St Dn / Rg / / /	73,50
	MT 150 85 720	St Dn / Rg / / /	73,50



FINAL STORM CONTRAPPESI MANUBRIO / BARENDS / LENKERENDENGEWICHTE / CONTRAPESOS / EMBOUTS DE GUIDONS

BRAND	MODEL	YEAR	CODE	COLOUR	EURO w/o tax	
APRILIA	CAPONORD 1200	'13	FS-BE	St Dn Ti Rg Cr Eb / / /	25,00	
	TUONO	'05-'14	FS-BE	St Dn Ti Rg Cr Eb / / /	25,00	
	TUONO V4	'11-'14	FS-BE	St Dn Ti Rg Cr Eb / / /	25,00	
	TUONO V4 1100 RR	'15	FS-BE	St Dn Ti Rg Cr Eb / / /	25,00	
	RSV 1000	/	FS-BE	St Dn Ti Rg Cr Eb / / /	25,00	
	RSV4 / FACTORY	/	FS-BE	St Dn Ti Rg Cr Eb / / /	25,00	
	RS 4 125	/	FS-TR1	St Dn Ti Rg Cr Eb / / /	25,00	
	RS 125	'07-'14	FS-SU	St Dn Ti Rg Cr Eb / / /	25,00	
	SHIVER	'08	FS-BE	St Dn Ti Rg Cr Eb / / /	25,00	
	SHIVER	'09-'10	FS-SU	St Dn Ti Rg Cr Eb / / /	25,00	
BENELLI	TNT/TREK / BN 600	/	FS-BE	St Dn Ti Rg Cr Eb / / Dks	25,00	
	S 1000 R	'15	FS-BMWS	St Dn Ti Rg Cr Eb / / /	25,00	
BMW	S 1000 RR	'09-'15	FS-BMWS	St Dn Ti Rg Cr Eb / / /	25,00	
	Tutti tranne/All except for Alle außer / Todos excepto		FS-U	St Dn Ti Rg Cr Eb Or Gr Dks	25,00	
DUCATI	Sauf puor: ST2,S4					
	PANIGALE 1289/1199/899	'12-'15	FS-DU1	St Dn Ti Rg Cr Eb / / /	25,00	
	CB 650 F	'14-'15	FS-HO	St Dn Ti Rg Cr Eb / / /	25,00	
	CB 1000 R	'08-'15	FS-HO	St Dn Ti Rg Cr Eb / / /	25,00	
	CB 1300	'08-'13	FS-HO	St Dn Ti Rg Cr Eb / / /	25,00	
	CBF 600/N	'08-'12	FS-HO	St Dn Ti Rg Cr Eb / / /	25,00	
	CBR 600 F/SP	'99-'06	FS-HO	St Dn Ti Rg Cr Eb / / /	25,00	
	CBR 600 F	'11-'13	FS-HO	St Dn Ti Rg Cr Eb / / /	25,00	
	CBR 600 RR	'03-'15	FS-HO	St Dn Ti Rg Cr Eb / / /	25,00	
	CBR 900 RR	'00-'03	FS-HO	St Dn Ti Rg Cr Eb / / /	25,00	
HONDA	CBR 1000 RR	'04-'15	FS-HO	St Dn Ti Rg Cr Eb / / /	25,00	
	CROSSRUNNER	'11-'14	FS-SU	St Dn Ti Rg Cr Eb / / /	25,00	
	INTEGRA	'12-'15	FS-HO	St Dn Ti Rg Cr Eb / / /	25,00	
	HORNET 600/900	/	FS-HO	St Dn Ti Rg Cr Eb / / /	25,00	
	VTR SP1/2	'01-'03	FS-HO	St Dn Ti Rg Cr Eb / / /	25,00	
	Nuda 900	'12-'13	FS-U	St Dn Ti Rg Cr Eb Or Gr Dks	25,00	
	ER6-N/F	'06-'15	FS-KA1	St Dn Ti Rg Cr Eb / Gr /	25,00	
	HUSQVARNA					
	KAWASAKI					

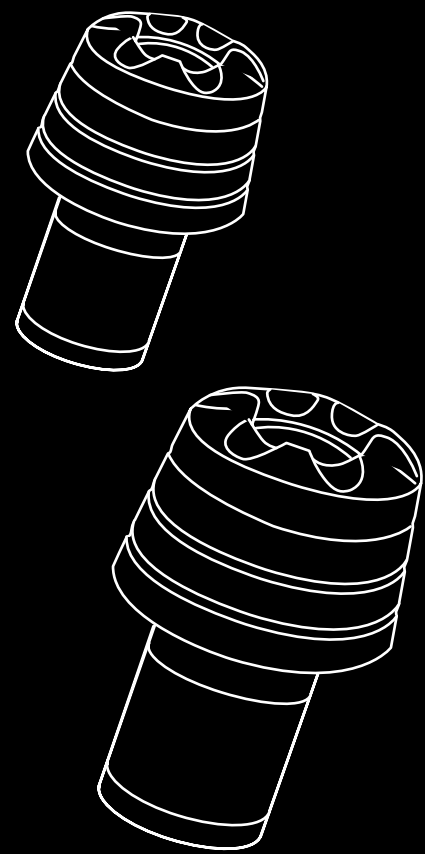

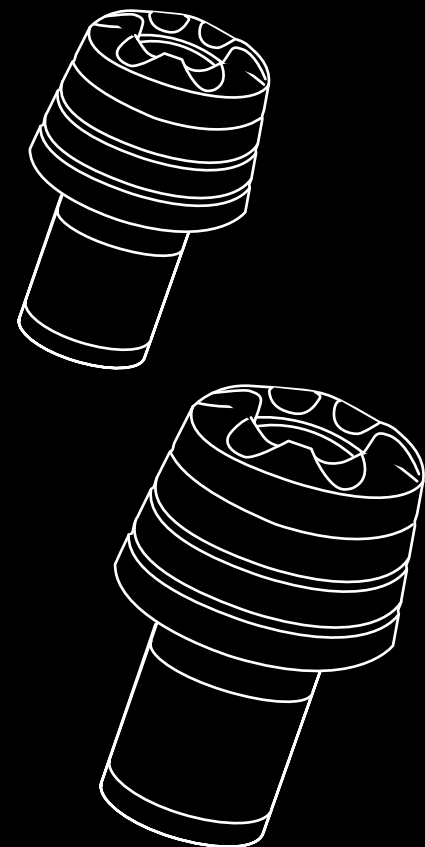

BRAND	MODEL	YEAR	CODE	COLOUR							EURO w/o tax		
KAWASAKI	Z 250	'15	FS-KA1	St	Dn	Ti	Rg	Cr	Eb	/	Gr	/	25,00
	Z 750	'03-'14	FS-KA1	St	Dn	Ti	Rg	Cr	Eb	/	Gr	/	25,00
	Z800	'13-'16	FS-KA1	St	Dn	Ti	Rg	Cr	Eb	/	Gr	/	25,00
	Z 1000/Z 1000 SX	'03-'16	FS-KA1	St	Dn	Ti	Rg	Cr	Eb	/	Gr	/	25,00
	VERSYS	'06-'15	FS-KA1	St	Dn	Ti	Rg	Cr	Eb	/	Gr	/	25,00
	ZX6R/RR	'98-'06	FS-KA1	St	Dn	Ti	Rg	Cr	Eb	/	Gr	/	25,00
	ZX6R/RR	'07-'15	FS-KA2	St	Dn	Ti	Rg	Cr	Eb	/	Gr	/	25,00
	ZX 636	'03-'15	FS-KA1	St	Dn	Ti	Rg	Cr	Eb	/	Gr	/	25,00
	ZX9R	'00-'04	FS-KA1	St	Dn	Ti	Rg	Cr	Eb	/	Gr	/	25,00
	ZX10R	'04-'15	FS-KA2	St	Dn	Ti	Rg	Cr	Eb	/	Gr	/	25,00
KTM	690 DUKE	'12 >	FS-U	St	Dn	Ti	Rg	Cr	Eb	Or	Gr	Dks	25,00
	690 SMC	/	FS-U	St	Dn	Ti	Rg	Cr	Eb	Or	Gr	Dks	25,00
	DUKE 125 / 390 NEW	'11-'14	FS-TR2	St	Dn	Ti	Rg	Cr	Eb	Or	/	/	25,00
	SUPERDUKE 990	/	FS-U	St	Dn	Ti	Rg	Cr	Eb	Or	Gr	Dks	25,00
	BRUTALE 675	'12-'15	FS-U	St	Dn	Ti	Rg	Cr	Eb	Or	Gr	Dks	25,00
	BRUTALE 750	>09	FS-MV	St	Dn	Ti	Rg	Cr	Eb	/	Gr	/	25,00
	BRUTALE 800	'12-'15	FS-U	St	Dn	Ti	Rg	Cr	Eb	Or	Gr	Dks	25,00
	BRUTALE 910 / R/S	>09	FS-MV	St	Dn	Ti	Rg	Cr	Eb	/	/	/	25,00
	BRUTALE 990 R	'10-'14	FS-U	St	Dn	Ti	Rg	Cr	Eb	Or	Gr	Dks	25,00
	BRUTALE 1090	'10-'14	FS-U	St	Dn	Ti	Rg	Cr	Eb	Or	Gr	Dks	25,00
MV AGUSTA	BRUTALE 1078	>09	FS-MV	St	Dn	Ti	Rg	Cr	Eb	/	/	/	25,00
	BRUTALE 1078	'10-'14	FS-U	St	Dn	Ti	Rg	Cr	Eb	Or	Gr	Dks	25,00
	DRAGSTER 800	'12-'15	FS-U	St	Dn	Ti	Rg	Cr	Eb	Or	Gr	Dks	25,00
	F4	>09	FS-MV	St	Dn	Ti	Rg	Cr	Eb	/	/	/	25,00
	F3	'12-'15	FS-MV	St	Dn	Ti	Rg	Cr	Eb	/	/	/	25,00
	B-KING	'08-'14	FS-U	St	Dn	Ti	Rg	Cr	Eb	Or	Gr	Dks	25,00
	GLADIUS	/	FS-SU	St	Dn	Ti	Rg	Cr	Eb	/	/	/	25,00
	GSR 600	'06-'11	FS-U	St	Dn	Ti	Rg	Cr	Eb	Or	Gr	Dks	25,00
	GSR 750	'11-'15	FS-SU	St	Dn	Ti	Rg	Cr	Eb	/	/	/	25,00
	GSR-R 600/750	'00-'05	FS-U	St	Dn	Ti	Rg	Cr	Eb	Or	Gr	Dks	25,00
SUZUKI	GSR-R 600/750	'06-'15	FS-SU	St	Dn	Ti	Rg	Cr	Eb	/	/	/	25,00
	GSR-R 1000	'00-'04	FS-U	St	Dn	Ti	Rg	Cr	Eb	Or	Gr	Dks	25,00
	GSR-R 1000	'05-'15	FS-SU	St	Dn	Ti	Rg	Cr	Eb	/	/	/	25,00
	GSX-S1000	'15	FS-U	St	Dn	Ti	Rg	Cr	Eb	Or	Gr	Dks	25,00
	SV 650/S	'00-'14	FS-U	St	Dn	Ti	Rg	Cr	Eb	Or	Gr	Dks	25,00
	SV 1000/S	'03-'13	FS-U	St	Dn	Ti	Rg	Cr	Eb	Or	Gr	Dks	25,00
	DAYTONA 675/R NEW	'13-'15	FS-TR2	St	Dn	Ti	Rg	Cr	Eb	/	/	/	25,00
	SPEED TRIPLE	'05-'10	FS-U	St	Dn	Ti	Rg	Cr	Eb	Or	Gr	Dks	25,00
	SPEED TRIPLE / R	'11-'15	FS-TR1	St	Dn	Ti	Rg	Cr	Eb	/	/	/	25,00
	STREET TRIPLE 675/R NEW	'11-'15	FS-TR2	St	Dn	Ti	Rg	Cr	Eb	/	/	/	25,00
TRIUMPH	FAZER 1000	'02-'04	FS-YA3	St	Dn	Ti	Rg	Cr	Eb	/	/	/	25,00
	FZ1 FAZER	'06 >	FS-YA3	St	Dn	Ti	Rg	Cr	Eb	/	/	/	25,00
	FZ1 NAKED	'06 >	FS-YA1	St	Dn	Ti	Rg	Cr	Eb	/	/	/	25,00
	FZ6	'04-'09	FS-YA3	St	Dn	Ti	Rg	Cr	Eb	/	/	/	25,00
	FZ8	'10 >	FS-YA1	St	Dn	Ti	Rg	Cr	Eb	/	/	/	25,00
	MT-07 / MT-09	'15	FS-YA3	St	Dn	Ti	Rg	Cr	Eb	/	/	/	25,00
	R1	'98-'15	FS-YA1	St	Dn	Ti	Rg	Cr	Eb	/	/	/	25,00
	R3	'15	FS-YA1	St	Dn	Ti	Rg	Cr	Eb	/	/	/	25,00
	R6	'06-'15	FS-YA1	St	Dn	Ti	Rg	Cr	Eb	/	/	/	25,00
	TDM 900	/	FS-YA3	St	Dn	Ti	Rg	Cr	Eb	/	/	/	25,00
YAMAHA	T-MAX	/	FS-YA3	St	Dn	Ti	Rg	Cr	Eb	/	/	/	25,00
	XJ6	'09 >	FS-YA3	St	Dn	Ti	Rg	Cr	Eb	/	/	/	25,00

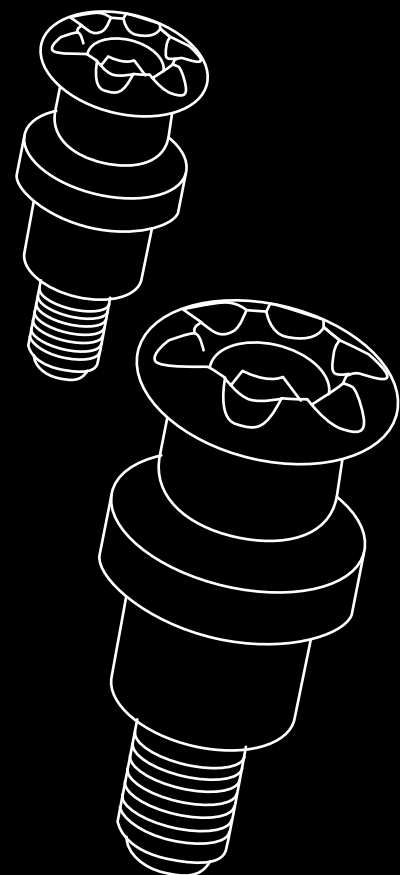

BRAND	MODEL	CODE	COLOUR							EURO w/o tax			
BMW	K1200S/R/Sport - K1300S/R - F800 '13	FS-BMW1	St	Dn	Ti	Rg	Cr	Eb	/	/	/	70,00	
	F800 R, R1200 ST, F650 GS *	FS-BMW2	St	Dn	Ti	Rg	Cr	Eb	/	/	/	70,00	
	R850 R, R1100 R, R1150 R, K1200	FS-BMW4	St	Dn	Ti	Rg	Cr	Eb	/	/	/	70,00	
	R 1200 R NEW	FS-BMW6	St	Dn	Ti	Rg	Cr	Eb	/	/	/	70,00	
	R NINE T '14 > NEW	FS-BMW5	St	Dn	Ti	Rg	Cr	Eb	/	/	/	70,00	
* Solo senza paramani / Only without hand protectors / Nur ohne Handschützer / Sin paramanos / Sans protège-mains													
NOTTOLINI CAVALLETTO / PADDOCK STANDS BOBBINS / AUFNAHMEHÜLSEN / SOPORTE DE CABALETES / DIABOLOS													
BRAND	MODEL	YEAR	CODE	COLOUR							EURO w/o tax		
APRILIA	CAPONORD 1200	'13 >	PS-M6	St	Dn	Ti	Rg	Cr	Eb	/	/	Dks	15,00
	DORSODURO	'08-'15	PS-M6	St	Dn	Ti	Rg	Cr	Eb	/	/	Dks	15,00
	SHIVER	'08 >	PS-M6	St	Dn	Ti	Rg	Cr	Eb	/	/	Dks	15,00
	RS 125	'11-'14	PS-M6	St	Dn	Ti	Rg	Cr	Eb	/	/	Dks	15,00
	RS V4	'05-'14	PS-M6b	St	Dn	Ti	Rg	Cr	Eb	/	/	Dks	15,00
	RS V 1000 R/Factory	'05-'14	PS-M6b	St	Dn	Ti	Rg	Cr	Eb	/	/	Dks	15,00
	RS V 1000 R/Factory/RSV4	'05-'14	PS-M6b	St	Dn	Ti	Rg	Cr	Eb	/	/	Dks	15,00
	TUONO 1000 R/Factory	'06-'11	PS-M6b	St	Dn	Ti	Rg	Cr	Eb	/	/	Dks	15,00
	TUONO V4 1100 RR	'15	PS-M6b	St	Dn	Ti	Rg	Cr	Eb	/	/	Dks	15,00
	BN 600	/	PS-M6c	St	Dn	Ti	Rg	Cr	Eb	/	/	/	15,00
BENELLI	S1000 R	'15	PS-M8b	St	Dn	Ti	Rg	Cr	Eb	/	Gr	/	15,00
	S1000 RR	'10-'15	PS-M8b	St	Dn	Ti	Rg	Cr	Eb	/	Gr	/	15,00
	S1000 XR	'15	PS-M8	St	Dn	Ti	Rg	Cr	Eb	/	Gr	/	15,00
	749/999 base/S/R	'05-'10	PS-M8	St	Dn	Ti	Rg	Cr	Eb	/	Gr	Dks	15,00
	MONSTER 821	'15	PS-M6c	St	Dn	Ti	Rg	Cr	Eb	/	/	/	15,00
	Tutti / All / Alle / Todos / Tous	/	PS-M8	St	Dn	Ti	Rg	Cr	Eb	/	Gr	Dks	15,00
	CBR 600 RR	'07-'15	PS-M8b	St	Dn	Ti	Rg	Cr	Eb	/	Gr	/	15,00
	ER6-N/F	'06-'08	PS-M10d	St	Dn	Ti	Rg	Cr	Eb	/	Gr	/	15,00
	ER6-N/F	'09-'16	PS-M10b	St	Dn	Ti	Rg	Cr	Eb	/	Gr	/	15,00
	VERSYS 650	'07-'14	PS-M10b	St	Dn	Ti	Rg	Cr	Eb	/	Gr	/	15,00
BMW	VERSYS 1000	'12-'14	PS-M10	St	Dn	Ti	Rg	Cr	Eb	/	Gr	/	15,00
	Z 250	'15	PS-M10b	St	Dn	Ti	Rg	Cr	Eb	/	Gr	/	15,00
	Z 750/S	'04 >	PS-M10b	St	Dn	Ti	Rg	Cr	Eb	/	Gr	/	15,00
	Z800	'13-'16	PS-M8b	St	Dn	Ti	Rg	Cr	Eb	/	Gr	/	15,00
	Z 1000	'03-'06	PS-M10	St	Dn	Ti	Rg	Cr	Eb	/	Gr	/	15,00
	Z 1000	'07-'09	PS-M10b	St	Dn	Ti	Rg	Cr	Eb	/	Gr	/	15,00
	Z 1000	'10-'13	PS-M10d	St	Dn	Ti	Rg	Cr	Eb	/	Gr	/	15,00
	Z 1000	'14-'16	PS-M8	St	Dn	Ti	Rg	Cr	Eb	/	Gr	Dks	15,00
	Z 1000 SX	'03-'13	PS-M10d	St	Dn	Ti	Rg	Cr	Eb	/	Gr	/	15,00
	Z 1000 SX	'14-'16	PS-M8	St	Dn	Ti	Rg	Cr	Eb	/	Gr	Dks	15,00
HONDA	ZX 6 R/RR	'03-'06	PS-M10	St	Dn	Ti	Rg	Cr	Eb	/	Gr	/	15,00
	ZX 6R	'07-'15	PS-M10b	St	Dn	Ti	Rg	Cr	Eb	/	Gr	/	15,00

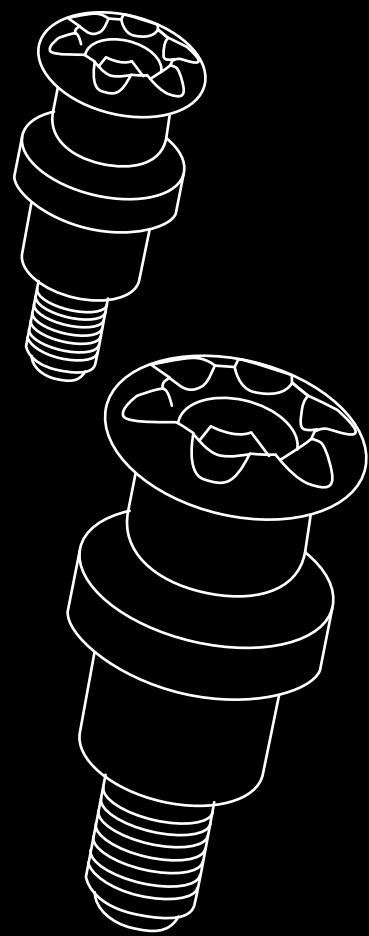

BRAND

KTM

SUZUKI

TRIUMPH

YAMAHA

BRAND

BENELLI

MODEL	YEAR	CODE	COLOUR							EURO w/o tax		
ZX 636	'13-'15	PS-M8b	St	Dn	Ti	Rg	Cr	Eb	/	Gr	/	15,00
ZX 10R	'04-'05	PS-M10	St	Dn	Ti	Rg	Cr	Eb	/	Gr	/	15,00
ZX 10R	'06-'07	PS-M10b	St	Dn	Ti	Rg	Cr	Eb	/	Gr	/	15,00
ZX 10R	'08-'10	PS-M10	St	Dn	Ti	Rg	Cr	Eb	/	Gr	/	15,00
ZX 10R	'11-'15	PS-M8	St	Dn	Ti	Rg	Cr	Eb	/	Gr	Dks	15,00
Filetto/Thread/Schraubengewinde Rosca/Filet M10 x 1,5	/	PS-M10c	St	Dn	/	/	/	/	Or	/	/	15,00
DUKE 125 / 390	/	PS-M10d	St	Dn	Ti	Rg	Cr	Eb	/	Gr	/	15,00
RC 8	/	PS-M8b	St	Dn	Ti	Rg	Cr	Eb	/	Gr	/	15,00
RC 125 / 390	/	PS-M10d	St	Dn	Ti	Rg	Cr	Eb	/	Gr	/	15,00
B-KING	'08-'14	PS-M8b	St	Dn	Ti	Rg	Cr	Eb	/	Gr	/	15,00
GLADIUS	/	PS-M8	St	Dn	Ti	Rg	Cr	Eb	/	Gr	Dks	15,00
GSR 600	'06-'11	PS-M8b	St	Dn	Ti	Rg	Cr	Eb	/	Gr	/	15,00
GSR 750	'11-'15	PS-M8	St	Dn	Ti	Rg	Cr	Eb	/	Gr	Dks	15,00
GSX-R 600/750	'97-'03	PS-M8	St	Dn	Ti	Rg	Cr	Eb	/	Gr	Dks	15,00
GSX-R 600/750	'04-'10	PS-M8b	St	Dn	Ti	Rg	Cr	Eb	/	Gr	/	15,00
GSX-R 600/750	'11-'15	PS-M8	St	Dn	Ti	Rg	Cr	Eb	/	Gr	Dks	15,00
GSX-R 1000	'01-'02	PS-M8	St	Dn	Ti	Rg	Cr	Eb	/	Gr	Dks	15,00
GSX-R 1000	'03-'15	PS-M8b	St	Dn	Ti	Rg	Cr	Eb	/	Gr	/	15,00
GSX-S 1000	'15	PS-M8	St	Dn	Ti	Rg	Cr	Eb	/	Gr	Dks	15,00
HAYABUSA	/	PS-M8b	St	Dn	Ti	Rg	Cr	Eb	/	Gr	/	15,00
SV 650/S	'00-'14	PS-M8	St	Dn	Ti	Rg	Cr	Eb	/	Gr	Dks	15,00
SV 1000/S	'03-'14	PS-M8b	St	Dn	Ti	Rg	Cr	Eb	/	Gr	/	15,00
DAYTONA 675	>'09	PS-M6	St	Dn	Ti	Rg	Cr	Eb	/	/	Dks	15,00
DAYTONA 675	'10-'12	PS-M8	St	Dn	Ti	Rg	Cr	Eb	/	Gr	Dks	15,00
DAYTONA 675/R	'13-'15	PS-M8b	St	Dn	Ti	Rg	Cr	Eb	/	Gr	/	15,00
STREET TRIPLE	>'09	PS-M6	St	Dn	Ti	Rg	Cr	Eb	/	/	Dks	15,00
STREET TRIPLE	'10-'12	PS-M8	St	Dn	Ti	Rg	Cr	Eb	/	Gr	Dks	15,00
STREET TRIPLE 675/R	'13-'15	PS-M8b	St	Dn	Ti	Rg	Cr	Eb	/	Gr	/	15,00
Tutti / All / Alle / Todos / Tous	/	PS-M6	St	Dn	Ti	Rg	Cr	Eb	/	/	Dks	15,00

* Sugeriamo di applicare dei frenafili sui modelli PS-M6 / We suggest to apply some thread glue only for the PS-M6 models / Wir empfehlen den Einsatz einer geeigneten Schrauben-sicherung (z.B. Loctite) für die PS-M6 Modelle / En los modelos PS-M6, recomendamos su montaje con una pequeña cantidad de fija tornillos o pegamento en su rosca / Il est conseillé d'utiliser du frein filet normal pour les modèles M6.

**SUPPORTI NOTTOLINI CAVALLETTO BENELLI / BENELLI PADDOCK STANDS SUPPORT
MONTAGESTÄNDER PADDOCK STANDS BOBBINS / SOPORTE DE CABALETES / SUPPORT DE DIABOLOS**

MODEL	CODE	COLOUR	EURO w/o tax
TnT / Trek	SPS-BE	/ Dn / / Cr /	100,00

* Sconto differente / Different discount / Anderer Rabatt / Diferente descuento / Remise différent

* Compatibili con nottolini PS-M6 / Suitable for PS-M6 bobbins model / Kompatibel mit PS-M6 montageständer / Solo es compatible con soporte de cabaletes PS-M6 / Compatible avec les diabolos PS-M6

**TAPPO SERBATOIO SGANCIO RAPIDO / RAPID GAS CAP / SCHNELLWECHSELTANKDECKEL
TAPÓN DEPÓSITO RAPIDO / BOUCHON DE RÉSERVOIR RAPIDE**

BRAND

APRILIA

BENELLI

BMW

DUCATI

HONDA

MODEL	CODE	COLOUR	EURO w/o tax
CAPONORD 1200	FCR-A2	St Dn Ti Rg Cr Eb / / /	120,00
SHIVER 750	FCR-ATB2	St Dn Ti Rg Cr Eb / / /	120,00
RS 4 125 '11-'14	FCR-ATB2	St Dn Ti Rg Cr Eb / / /	120,00
RS 125 '06-'14	FCR-ATB2	St Dn Ti Rg Cr Eb / / /	120,00
RS 250 '98 >	FCR-ATB2	St Dn Ti Rg Cr Eb / / /	120,00
RS V4 FACTORY/R '09-'14	FCR-A2	St Dn Ti Rg Cr Eb / / /	120,00
RS V 1000 / R/FACTORY >'03	FCR-ATB2	St Dn Ti Rg Cr Eb / / /	120,00
RS V 1000 / R/FACTORY '04 >	FCR-A2	St Dn Ti Rg Cr Eb / / /	120,00
TUONO V4 '11-'14	FCR-A2	St Dn Ti Rg Cr Eb / / /	120,00
TUONO V4 1100 RR '15	FCR-A2	St Dn Ti Rg Cr Eb / / /	120,00
TUONO 1000 R / FACTORY > '05	FCR-ATB2	St Dn Ti Rg Cr Eb / / /	120,00
TUONO 1000 R/FACTORY '06 >	FCR-A2	St Dn Ti Rg Cr Eb / / /	120,00
BENELLI TNT 899/1130/BN 600	FCR-ATB2	St Dn Ti Rg Cr Eb / / /	120,00
1200 R '08	FCR-BMW	St Dn Ti Rg Cr Eb / / /	120,00
HP2 SPORT R	FCR-BMW	St Dn Ti Rg Cr Eb / / /	120,00
HP4 '13	/	St Dn Ti Rg Cr Eb / / /	/
R 1200 S '06	FCR-BMW	St Dn Ti Rg Cr Eb / / /	120,00
S 1000 R '15	FCR-BMW	St Dn Ti Rg Cr Eb / / /	120,00
S 1000 RR '11-'15	FCR-BMW	St Dn Ti Rg Cr Eb / / /	120,00
748/800/848	FCR-DMY	St Dn Ti Rg Cr Eb / / /	100,00
916/996/998	FCR-DMY	St Dn Ti Rg Cr Eb / / /	100,00
1098/1198	FCR-DMY	St Dn Ti Rg Cr Eb / / /	100,00
DIAVEL	FCR-DU2	St Dn Ti Rg Cr Eb / / /	100,00
MONSTER 600	FCR-DMY	St Dn Ti Rg Cr Eb / / /	100,00
MONSTER 620	FCR-DMY	St Dn Ti Rg Cr Eb / / /	100,00
MONSTER 695	FCR-DMY	St Dn Ti Rg Cr Eb / / /	100,00
MONSTER 696	FCR-DU2	St Dn Ti Rg Cr Eb / / /	100,00
MONSTER 750	FCR-DMY	St Dn Ti Rg Cr Eb / / /	100,00
MONSTER 796	FCR-DU2	St Dn Ti Rg Cr Eb / / /	100,00
MONSTER 900	FCR-DMY	St Dn Ti Rg Cr Eb / / /	100,00
MONSTER 1000	FCR-DMY	St Dn Ti Rg Cr Eb / / /	100,00
MONSTER 1100	FCR-DU2	St Dn Ti Rg Cr Eb / / /	100,00
MONSTER 1100 Evo	FCR-DU2	St Dn Ti Rg Cr Eb / / /	100,00
MONSTER 1200	/	St Dn Ti Rg Cr Eb / / /	/
PANIGALE 1299 / 1199 '12 / 899 '14	FCR-DU3	St Dn Ti Rg Cr Eb / / /	120,00
S2R/S4/S4R	FCR-DMY	St Dn Ti Rg Cr Eb / / /	100,00
STREETFIGHTER '09 >	FCR-A2	St Dn Ti Rg Cr Eb / / /	120,00
CROSSRUNNER ^(All)	FCR-HO	St Dn Ti Rg Cr Eb / / /	100,00
CB 650 F ^(All)	FCR-HO	St Dn Ti Rg Cr Eb / / /	100,00
CB 1000 R ^(All)	FCR-HO	St Dn Ti Rg Cr Eb / / /	100,00
CB 1300 ^(All)	FCR-HO	St Dn Ti Rg Cr Eb / / /	100,00
CBF 600 / N ^(All)	FCR-HO	St Dn Ti Rg Cr Eb / / /	100,00
CBF 600 / N / S ^(All)	FCR-HO	St Dn Ti Rg Cr Eb / / /	100,00
CBF 1000 ^(All)	FCR-HO	St Dn Ti Rg Cr Eb / / /	100,00
CBF 1000 / ST ^(All)	FCR-HO	St Dn Ti Rg Cr Eb / / /	100,00
CBR 125 ^(All)	FCR-HO	St Dn Ti Rg Cr Eb / / /	100,00
CBR 250 CC ^(All)	FCR-HO	St Dn Ti Rg Cr Eb / / /	100,00

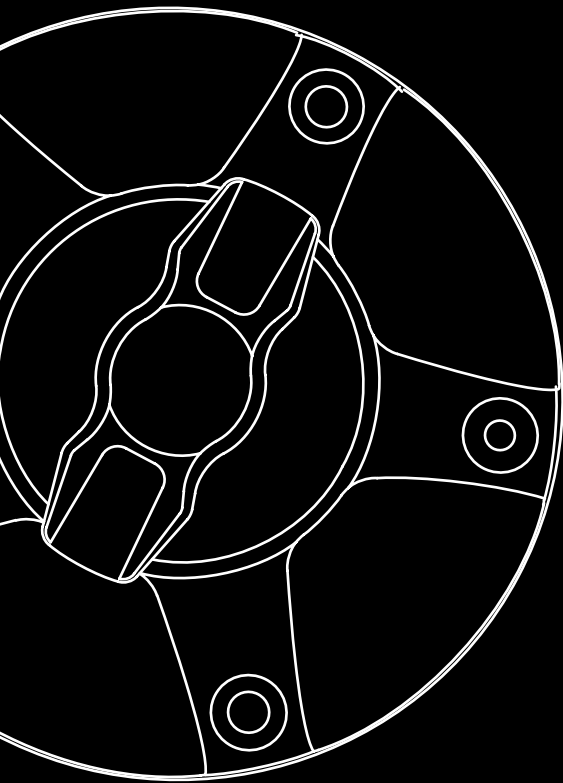

BRAND	MODEL	CODE	COLOUR	EURO w/o tax
HONDA	CBR 600 F (All)	FCR-HO	St Dn Ti Rg Cr Eb / / /	100,00
	CBR 600 RR (All)	FCR-HO	St Dn Ti Rg Cr Eb / / /	100,00
	CBR 900 RR (All)	FCR-HO	St Dn Ti Rg Cr Eb / / /	100,00
	CBR 929 RR (All)	FCR-HO	St Dn Ti Rg Cr Eb / / /	100,00
	CBR 954 RR (All)	FCR-HO	St Dn Ti Rg Cr Eb / / /	100,00
	CBR 1000 RR '04-'13	FCR-HO	St Dn Ti Rg Cr Eb / / /	100,00
	CBR 1100 XX (All)	FCR-HO	St Dn Ti Rg Cr Eb / / /	100,00
	CBR FIREBLADE (All)	FCR-HO	St Dn Ti Rg Cr Eb / / /	100,00
	HORNET 600 (All)	FCR-HO	St Dn Ti Rg Cr Eb / / /	100,00
	HORNET 600 S (All)	FCR-HO	St Dn Ti Rg Cr Eb / / /	100,00
	HORNET 900 (All)	FCR-HO	St Dn Ti Rg Cr Eb / / /	100,00
	INTEGRA (All)	FCR-HO	St Dn Ti Rg Cr Eb / / /	100,00
	NC 700 (All)	FCR-HO	St Dn Ti Rg Cr Eb / / /	100,00
	750 X (All)	FCR-HO	St Dn Ti Rg Cr Eb / / /	100,00
	VFR 750 / 800 / 1000 F (All)	FCR-HO	St Dn Ti Rg Cr Eb / / /	100,00
	VTR SP1 / VTR SP2 (All)	FCR-HO	St Dn Ti Rg Cr Eb / / /	100,00
	ER6N/F '06 - '16	FCR-KA2	St Dn Ti Rg Cr Eb / / /	100,00
	VERSYS '07-'14	FCR-KA2	St Dn Ti Rg Cr Eb / / /	100,00
	Z 750 '07 >	FCR-KA2	St Dn Ti Rg Cr Eb / / /	100,00
	Z 800 '14-'16	FCR-KA2	St Dn Ti Rg Cr Eb / / /	100,00
Z 1000 '07-'16	FCR-KA2	St Dn Ti Rg Cr Eb / / /	100,00	
Z 1000 SX '11-'16	FCR-KA2	St Dn Ti Rg Cr Eb / / /	100,00	
ZX 6R	FCR-KA2	St Dn Ti Rg Cr Eb / / /	100,00	
ZX 6RR	FCR-KA2	St Dn Ti Rg Cr Eb / / /	100,00	
ZX 10R	FCR-KA2	St Dn Ti Rg Cr Eb / / /	100,00	
ZX 14R	FCR-KA2	St Dn Ti Rg Cr Eb / / /	100,00	
ZZR 1400	FCR-KA2	St Dn Ti Rg Cr Eb / / /	100,00	
KTM	690 DUKE '12>	FCR-ATB2	St Dn Ti Rg Cr Eb / / /	120,00
	RC8	FCR-A2	St Dn Ti Rg Cr Eb / / /	120,00
	SUPERDUKE 1290 R	/	St Dn Ti Rg Cr Eb / / /	/
	BRUTALE 675	FCR-ATB2	St Dn Ti Rg Cr Eb / / /	120,00
	BRUTALE 750 ^{5 Viti/Bolts/Schrauben/Tornillo/Vis}	FCR-DMY	St Dn Ti Rg Cr Eb / / /	100,00
	BRUTALE 800	FCR-ATB2	St Dn Ti Rg Cr Eb / / /	120,00
	BRUTALE 910/S/R ^{5 Viti/Bolts/Schrauben/Tornillo/Vis}	FCR-DMY	St Dn Ti Rg Cr Eb / / /	100,00
	BRUTALE 990/R '10-'12	FCR-A2	St Dn Ti Rg Cr Eb / / /	120,00
	BRUTALE 1078 '09-'15	FCR-A2	St Dn Ti Rg Cr Eb / / /	120,00
	BRUTALE 1090 / R / RR '10-'12	FCR-A2	St Dn Ti Rg Cr Eb / / /	120,00
MV AGUSTA	DRAGSTER 800	FCR-ATB2	St Dn Ti Rg Cr Eb / / /	120,00
	F3	FCR-ATB2	St Dn Ti Rg Cr Eb / / /	120,00
	F4 '10-'15	FCR-A2	St Dn Ti Rg Cr Eb / / /	120,00
	RIVALE	FCR-ATB2	St Dn Ti Rg Cr Eb / / /	120,00
	BANDIT GSF 650/S	FCR-SU2	St Dn Ti Rg Cr Eb / / /	100,00
	BANDIT GSF 1200	FCR-SU2	St Dn Ti Rg Cr Eb / / /	100,00
	BANDIT GSF 1250	FCR-SU2	St Dn Ti Rg Cr Eb / / /	100,00
	GLADIUS	FCR-SU2	St Dn Ti Rg Cr Eb / / /	100,00
	GSR 600 '06-'11	FCR-SU2	St Dn Ti Rg Cr Eb / / /	100,00
	GSR 750 '11-'15	FCR-SU2	St Dn Ti Rg Cr Eb / / /	100,00
SUZUKI	GSX-F 650 '08-'15	FCR-SU2	St Dn Ti Rg Cr Eb / / /	100,00
	GSX-R 600 '04-'15	FCR-SU2	St Dn Ti Rg Cr Eb / / /	100,00
	GSX-R 750 '04-'15	FCR-SU2	St Dn Ti Rg Cr Eb / / /	100,00
	GSX-R 1000 '03-'15	FCR-SU2	St Dn Ti Rg Cr Eb / / /	100,00

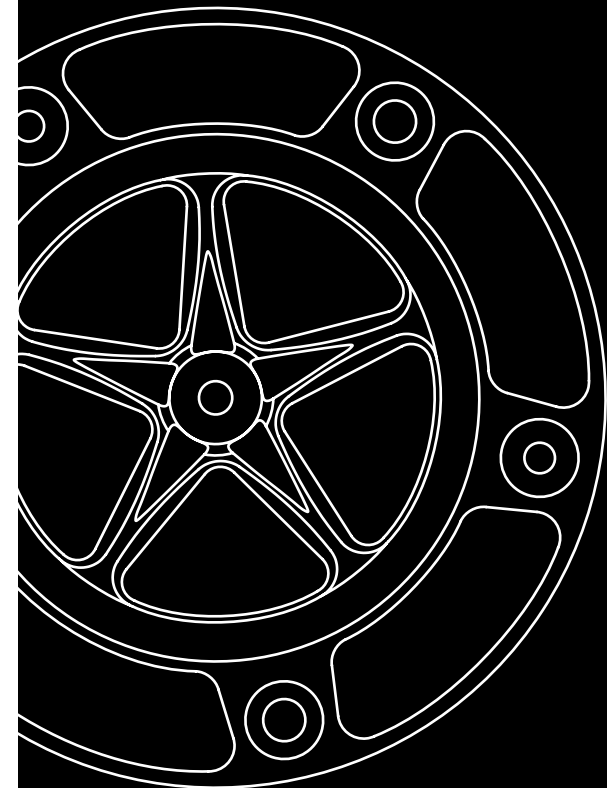

BRAND	MODEL	CODE	COLOUR	EURO w/o tax	
SUZUKI	GSX-R 1300 '08-'14	FCR-SU2	St Dn Ti Rg Cr Eb / / /	100,00	
	GSX-S 1000 '15	FCR-SU2	St Dn Ti Rg Cr Eb / / /	100,00	
	SV650/SV1000	FCR-SU2	St Dn Ti Rg Cr Eb / / /	100,00	
	DAYTONA 675/R '06-'12	FCR-ATB2	St Dn Ti Rg Cr Eb / / /	120,00	
	DAYTONA 675/R '14>	FCR-ATB2	St Dn Ti Rg Cr Eb / / /	120,00	
	DAYTONA 955 I	FCR-ATB2	St Dn Ti Rg Cr Eb / / /	120,00	
	DAYTONA T 955 '02-'04	FCR-ATB2	St Dn Ti Rg Cr Eb / / /	120,00	
	SPEED TRIPLE T955 '02-'04	FCR-ATB2	St Dn Ti Rg Cr Eb / / /	120,00	
	SPEED TRIPLE/R '05-'15	FCR-ATB2	St Dn Ti Rg Cr Eb / / /	120,00	
	STREET TRIPLE '07	FCR-ATB2	St Dn Ti Rg Cr Eb / / /	120,00	
TRIUMPH	STREET TRIPLE 675R	FCR-ATB2	St Dn Ti Rg Cr Eb / / /	120,00	
	Tutti / All / Alle / Todos / Tous	FCR-DMY	St Dn Ti Rg Cr Eb / / /	100,00	
	MT-01/XVS ROAD STAR WORRIOR 1700 '03-'04	FCR-YA2	St Dn Ti Rg Cr Eb / / /	100,00	
	R1 '15	/	St Dn Ti Rg Cr Eb / / /	/	
	Tappo universale / Universal cap / Universelle Innendeckel Tapón universal / Bouchon universell		FCR-U2	St Dn Ti Rg Cr Eb Or Gr /	/
	YAMAHA	CAPONORD 1200	FC-A2	St Dn Ti Rg Cr Eb / / /	70,00
		RS125 '06 >	FC-ATB2	St Dn Ti Rg Cr Eb / / /	70,00
		RS 250 '98 >	FC-ATB2	St Dn Ti Rg Cr Eb / / /	70,00
		RS 4 125 '11-'14	FC-ATB2	St Dn Ti Rg Cr Eb / / /	70,00
		RS V4 /R/FACTORY	FC-A2	St Dn Ti Rg Cr Eb / / /	70,00
RS V 1000/R/Factory '01-'03		FC-ATB2	St Dn Ti Rg Cr Eb / / /	70,00	
RS V 1000/R/Factory '04-'09		FC-A2	St Dn Ti Rg Cr Eb / / /	70,00	
SHIVER 750		FC-ATB2	St Dn Ti Rg Cr Eb / / /	70,00	
TUONO 1000 >'05		FC-ATB2	St Dn Ti Rg Cr Eb / / /	70,00	
TUONO 1000 R '06-'10		FC-A2	St Dn Ti Rg Cr Eb / / /	70,00	
TUONO V4 '11-'15	FC-A2	St Dn Ti Rg Cr Eb / / /	70,00		
APRILIA	TUONO V4 1100 RR '15	FC-A2	St Dn Ti Rg Cr Eb / / /	70,00	
	BN 600	FC-ATB2	St Dn Ti Rg Cr Eb / / /	70,00	
	TNT 899/1130/BN 600	FC-ATB2	St Dn Ti Rg Cr Eb / / /	70,00	
	TORNADO 900	FC-ATB2	St Dn Ti Rg Cr Eb / / /	70,00	
	R NINET T 2014	FC-BMW2	St Dn Ti Rg Cr Eb / / /	70,00	
	S 1000 R '15	FC-BMW1	St Dn Ti Rg Cr Eb / / /	70,00	
	S 1000 RR '09-'15	FC-BMW1	St Dn Ti Rg Cr Eb / / /	70,00	
	GPR 125	FC-ATB2	St Dn Ti Rg Cr Eb / / /	70,00	
	748 / 916 / 996 / 998	FC-DU	St Dn Ti Rg Cr Eb / / /	70,00	
	848 / 888 SP5	FC-DU	St Dn Ti Rg Cr Eb / / /	70,00	
BENELLI	916 / 996 / 998	FC-DU	St Dn Ti Rg Cr Eb / / /	70,00	
	1098 / 1198	FC-DU	St Dn Ti Rg Cr Eb / / /	70,00	
	GT 1000 '07 -	FC-DU	St Dn Ti Rg Cr Eb / / /	70,00	
	MONSTER 821 / 1200	FC-DU	St Dn Ti Rg Cr Eb / / /	70,00	
	PAUL SMART 1000	FC-DU	St Dn Ti Rg Cr Eb / / /	70,00	
	BMW	BRUTALE 675	FCR-ATB2	St Dn Ti Rg Cr Eb / / /	120,00
		BRUTALE 750 ^{5 Viti/Bolts/Schrauben/Tornillo/Vis}	FCR-DMY	St Dn Ti Rg Cr Eb / / /	100,00
		BRUTALE 800	FCR-ATB2	St Dn Ti Rg Cr Eb / / /	120,00
		BRUTALE 910/S/R ^{5 Viti/Bolts/Schrauben/Tornillo/Vis}	FCR-DMY	St Dn Ti Rg Cr Eb / / /	100,00
		BRUTALE 990/R '10-'12	FCR-A2	St Dn Ti Rg Cr Eb / / /	120,00
BRUTALE 1078 '09-'15		FCR-A2	St Dn Ti Rg Cr Eb / / /	120,00	
BRUTALE 1090 / R / RR '10-'12		FCR-A2	St Dn Ti Rg Cr Eb / / /	120,00	
DRAGSTER 800		FCR-ATB2	St Dn Ti Rg Cr Eb / / /	120,00	
F3		FCR-ATB2	St Dn Ti Rg Cr Eb / / /	120,00	
F4 '10-'15		FCR-A2	St Dn Ti Rg Cr Eb / / /	120,00	
DUCATI	RIVALE	FCR-ATB2	St Dn Ti Rg Cr Eb / / /	120,00	
	BANDIT GSF 650/S	FCR-SU2	St Dn Ti Rg Cr Eb / / /	100,00	
	BANDIT GSF 1200	FCR-SU2	St Dn Ti Rg Cr Eb / / /	100,00	
	BANDIT GSF 1250	FCR-SU2	St Dn Ti Rg Cr Eb / / /	100,00	
	GLADIUS	FCR-SU2	St Dn Ti Rg Cr Eb / / /	100,00	
	GSR 600 '06-'11	FCR-SU2	St Dn Ti Rg Cr Eb / / /	100,00	
	GSR 750 '11-'15	FCR-SU2	St Dn Ti Rg Cr Eb / / /	100,00	
	GSX-F 650 '08-'15	FCR-SU2	St Dn Ti Rg Cr Eb / / /	100,00	
	GSX-R 600 '04-'15	FCR-SU2	St Dn Ti Rg Cr Eb / / /	100,00	
	GSX-R 750 '04-'15	FCR-SU2	St Dn Ti Rg Cr Eb / / /	100,00	

TAPPO SERBATOIO A VITE / FULL SPIN GAS CAP / TANKDECKEL / TAPÓN GASOLINA / TRAPPE À ESSENCE

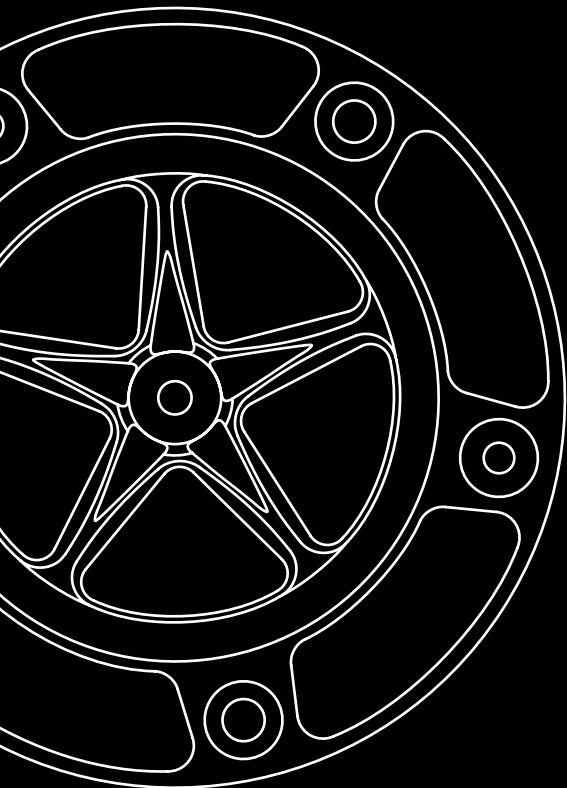

BRAND

DUCATI

HONDA

KAWASAKI

KTM

MV AGUSTA

MODEL	CODE	COLOUR	EURO w/o tax
SS 620 / 800 / 900	FC-DU	Dn Ti Rg Cr Eb / /	70,00
STREETFIGHTER	FC-A2	Dn Ti Rg Cr Eb / /	70,00
CB 650 F (All)	FC-HO	Dn Ti Rg Cr Eb / /	70,00
CB 1000 R (All)	FC-HO	Dn Ti Rg Cr Eb / /	70,00
CB 1300 (All)	FC-HO	Dn Ti Rg Cr Eb / /	70,00
CBF 600 / N (All)	FC-HO	Dn Ti Rg Cr Eb / /	70,00
CBF 600 / N / S (All)	FC-HO	Dn Ti Rg Cr Eb / /	70,00
CBF 1000 (All)	FC-HO	Dn Ti Rg Cr Eb / /	70,00
CBF 1000 / ST (All)	FC-HO	Dn Ti Rg Cr Eb / /	70,00
CBR 125 (All)	FC-HO	Dn Ti Rg Cr Eb / /	70,00
CBR 250 CC (All)	FC-HO	Dn Ti Rg Cr Eb / /	70,00
CBR 600 F (All)	FC-HO	Dn Ti Rg Cr Eb / /	70,00
CBR 600 RR (All)	FC-HO	Dn Ti Rg Cr Eb / /	70,00
CBR 900 RR (All)	FC-HO	Dn Ti Rg Cr Eb / /	70,00
CBR 929 RR (All)	FC-HO	Dn Ti Rg Cr Eb / /	70,00
CBR 954 RR (All)	FC-HO	Dn Ti Rg Cr Eb / /	70,00
CBR 1000 RR '04-'13	FC-HO	Dn Ti Rg Cr Eb / /	70,00
CBR 1100 XX (All)	FC-HO	Dn Ti Rg Cr Eb / /	70,00
CBR FIREBLADE (All)	FC-HO	Dn Ti Rg Cr Eb / /	70,00
CROSSRUNNER (All)	FC-HO	Dn Ti Rg Cr Eb / /	70,00
HORNET 600 / 600 S / 900 (All)	FC-HO	Dn Ti Rg Cr Eb / /	70,00
INTEGRA (All)	FC-HO	Dn Ti Rg Cr Eb / /	70,00
NC 700 / 750 X (All)	FC-HO	Dn Ti Rg Cr Eb / /	70,00
VFR 750 / 800 / 1000 F (All)	FC-HO	Dn Ti Rg Cr Eb / /	70,00
VTR SP1 / VTR SP2 (All)	FC-HO	Dn Ti Rg Cr Eb / /	70,00
ER6N/F '06-'08	FC-KA1	Dn Ti Rg Cr Eb / /	70,00
ER6N/F '09-'15	FC-KA2	Dn Ti Rg Cr Eb / /	70,00
VERSYS '07-'14	FC-KA2	Dn Ti Rg Cr Eb / /	70,00
Z 250 / Z 300 '15	FC-KA3	Dn Ti Rg Cr Eb / /	45,00
Z 750 '04-'06	FC-KA1	Dn Ti Rg Cr Eb / /	70,00
Z 750 '07 >	FC-KA2	Dn Ti Rg Cr Eb / /	70,00
Z 800 '15-'16	FC-KA2	Dn Ti Rg Cr Eb / /	70,00
Z 1000 '03-'06	FC-KA1	Dn Ti Rg Cr Eb / /	70,00
Z 1000 '07-'16	FC-KA2	Dn Ti Rg Cr Eb / /	70,00
Z 1000 SX '11-'16	FC-KA2	Dn Ti Rg Cr Eb / /	70,00
ZX 6 R '07-'15	FC-KA2	Dn Ti Rg Cr Eb / /	70,00
ZX 6 R/RR '03-'06	FC-KA1	Dn Ti Rg Cr Eb / /	70,00
ZX 9R '00-'04	FC-KA1	Dn Ti Rg Cr Eb / /	70,00
ZX 10R '04-'05	FC-KA1	Dn Ti Rg Cr Eb / /	70,00
ZX 10R '06-'15	FC-KA2	Dn Ti Rg Cr Eb / /	70,00
ZX 14R	FC-KA2	Dn Ti Rg Cr Eb / /	70,00
ZX 250 '08-'14	FC-KA3	Dn Ti Rg Cr Eb / /	45,00
ZX 636 '15	FC-KA2	Dn Ti Rg Cr Eb / /	70,00
ZZR 1400	FC-KA2	Dn Ti Rg Cr Eb / /	70,00
690 DUKE '12-'15	FC-ATB2	Dn Ti Rg Cr Eb / /	70,00
990 SUPERDUKE	FC-ATB2	Dn Ti Rg Cr Eb / /	70,00
950 ADVENTURE	FC-ATB2	Dn Ti Rg Cr Eb / /	70,00
990 ADVENTURE	FC-ATB2	Dn Ti Rg Cr Eb / /	70,00
RC8	FC-A2	Dn Ti Rg Cr Eb / /	70,00
BRUTALE	FC-A2	Dn Ti Rg Cr Eb / /	70,00
BRUTALE 675	FC-ATB2	Dn Ti Rg Cr Eb / /	70,00

BRAND

MV AGUSTA

SUZUKI 7 Viti
Bolts / Schrauben
Tornillo / Vis

SUZUKI 5 Viti
Bolts / Schrauben
Tornillo / Vis

TRIUMPH

YAMAHA

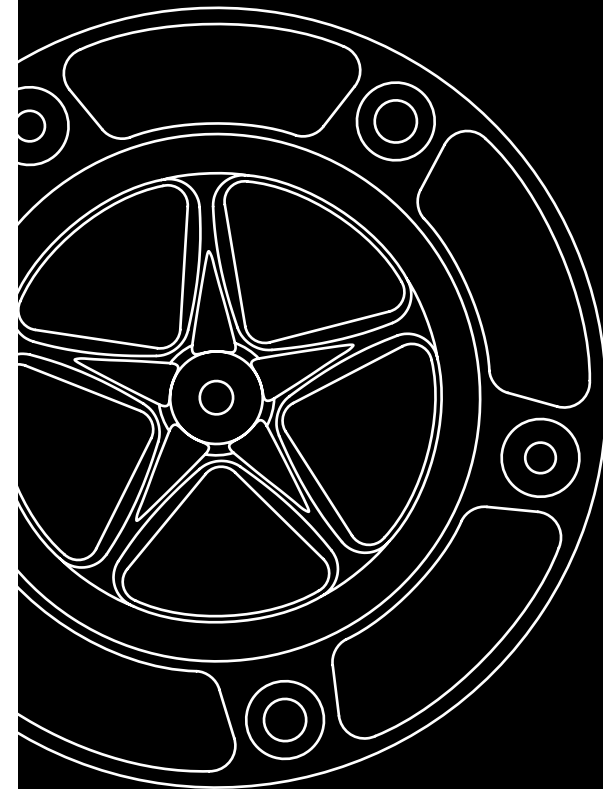

MODEL	CODE	COLOUR	EURO w/o tax
BRUTALE 800	FC-ATB2	Dn Ti Rg Cr Eb / /	70,00
DRAGSTER 800	FC-ATB2	Dn Ti Rg Cr Eb / /	70,00
F3	FC-ATB2	Dn Ti Rg Cr Eb / /	70,00
F4 '10>	FC-A2	Dn Ti Rg Cr Eb / /	70,00
RIVALE	FC-ATB2	Dn Ti Rg Cr Eb / /	70,00
BANDIT GSF 1200 >'06	FC-SU1	Dn Ti Rg Cr Eb / /	70,00
BANDIT GSF 600 / S	FC-SU1	Dn Ti Rg Cr Eb / /	70,00
DL 1000 V-STROM	FC-SU1	Dn Ti Rg Cr Eb / /	70,00
DL 650 V-STROM	FC-SU1	Dn Ti Rg Cr Eb / /	70,00
GS 500	FC-SU1	Dn Ti Rg Cr Eb / /	70,00
GSX 1400	FC-SU1	Dn Ti Rg Cr Eb / /	70,00
GSX 750 F	FC-SU1	Dn Ti Rg Cr Eb / /	70,00
GSX 750 NAKED	FC-SU1	Dn Ti Rg Cr Eb / /	70,00
GSX-F 600 '97-'00	FC-SU1	Dn Ti Rg Cr Eb / /	70,00
GSX-F 750 F '98 >	FC-SU1	Dn Ti Rg Cr Eb / /	70,00
GSX-R 1000 '01-'02	FC-SU1	Dn Ti Rg Cr Eb / /	70,00
GSX R 1100 '91-'97	FC-SU1	Dn Ti Rg Cr Eb / /	70,00
GSX R 1300 HAYABUSA >'07	FC-SU1	Dn Ti Rg Cr Eb / /	70,00
GSX R 600 '97-'03	FC-SU1	Dn Ti Rg Cr Eb / /	70,00
GSX R 750 '92-'03	FC-SU1	Dn Ti Rg Cr Eb / /	70,00
RF 600/RF900	FC-SU1	Dn Ti Rg Cr Eb / /	70,00
SV 650/S-'02	FC-SU1	Dn Ti Rg Cr Eb / /	70,00
TL 1000 R/S	FC-SU1	Dn Ti Rg Cr Eb / /	70,00
XF 650 FREEWIND	FC-SU1	Dn Ti Rg Cr Eb / /	70,00
BANDIT GSF 1200 / 1250 '07 <	FC-SU2	Dn Ti Rg Cr Eb / /	70,00
BANDIT GSF 650/S '05 >	FC-SU2	Dn Ti Rg Cr Eb / /	70,00
GLADIUS '06-'11	FC-SU2	Dn Ti Rg Cr Eb / /	70,00
GSR 600 / GSR 750 '11-'15	FC-SU2	Dn Ti Rg Cr Eb / /	70,00
GSX F 650 '08-'14	FC-SU2	Dn Ti Rg Cr Eb / /	70,00
GSX R 1000 '03-'14	FC-SU2	Dn Ti Rg Cr Eb / /	70,00
GSX R 1300 '08-'15	FC-SU2	Dn Ti Rg Cr Eb / /	70,00
GSX R 600 / 750 '04-'15	FC-SU2	Dn Ti Rg Cr Eb / /	70,00
GSX S 1000 '15	FC-SU2	Dn Ti Rg Cr Eb / /	70,00
HAYABUSA	FC-SU2	Dn Ti Rg Cr Eb / /	70,00
SV 1000	FC-SU2	Dn Ti Rg Cr Eb / /	70,00
SV 650/S	FC-SU2	Dn Ti Rg Cr Eb / /	70,00
BONNEVILLE	FC-VI1	Dn / / / / /	70,00
DAYTONA 675 '06-'12	FC-ATB2	Dn Ti Rg Cr Eb / /	70,00
DAYTONA 675 / R '13-'15	FC-ATB2	Dn Ti Rg Cr Eb / /	70,00
DAYTONA 955 I / T955 '02-'04	FC-ATB2	Dn Ti Rg Cr Eb / /	70,00
LEGENT TT	FC-VI1	Dn / / / / /	70,00
SCRAMBLER	FC-VI1	Dn / / / / /	70,00
SPORT	FC-VI1	Dn / / / / /	70,00
SPEED TRIPLE T955 '02-'04	FC-ATB2	Dn Ti Rg Cr Eb / /	70,00
SPEED TRIPLE 1050 '11-'15	FC-ATB2	Dn Ti Rg Cr Eb / /	70,00
STREET TRIPLE '07-'12	FC-ATB2	Dn Ti Rg Cr Eb / /	70,00
STREET TRIPLE 675/R '13-'15	FC-ATB2	Dn Ti Rg Cr Eb / /	70,00
THRUXTON	FC-VI1	Dn / / / / /	70,00
THUNDERBIRD	FC-VI1	Dn / / / / /	70,00
BULLDOG	FC-YA	Dn Ti Rg Cr Eb / /	70,00

BRAND	MODEL	CODE	COLOUR	EURO w/o tax
YAMAHA	FAZER 600 > '03	FC-YA	St Dn Ti Rg Cr Eb / /	70,00
	FZ 1/FAZER 1000 '05 >	FC-YA	St Dn Ti Rg Cr Eb / /	70,00
	FZ 1 NAKED '06 >	FC-YA	St Dn Ti Rg Cr Eb / /	70,00
	FZ 6 / FZ 6 S2	FC-YA	St Dn Ti Rg Cr Eb / /	70,00
	FZ 8	FC-YA	St Dn Ti Rg Cr Eb / /	70,00
	MT-03	FC-YA	St Dn Ti Rg Cr Eb / /	70,00
	MT-07 '14 >	FC-YA2	St Dn Ti Rg Cr Eb / /	70,00
	MT-09 '14	FC-YA	St Dn Ti Rg Cr Eb / /	70,00
	R1 '00-'13-'14	FC-YA	St Dn Ti Rg Cr Eb / /	70,00
	R3 '15	FC-YA	St Dn Ti Rg Cr Eb / /	70,00
	R6 '99-'15	FC-YA	St Dn Ti Rg Cr Eb / /	70,00
	TDM 900	FC-YA	St Dn Ti Rg Cr Eb / /	70,00
	THUNDERACE 1000	FC-YA	St Dn Ti Rg Cr Eb / /	70,00
	THUNDERCAT 600	FC-YA	St Dn Ti Rg Cr Eb / /	70,00
	XJ6	FC-YA	St Dn Ti Rg Cr Eb / /	70,00
	XJR 1300	FC-YA	St Dn Ti Rg Cr Eb / /	70,00
		Tappo universale / Universal cap / Universelle Innendeckel Tapón universal / Bouchon universell	FC-U	St Dn Ti Rg Cr Eb Gr Dks /

* La viteria non è compresa. Consultare la sezione kit viti serbatoio a pagina 49 / Bolts kit is not included. See page 49 to order the right kit / Schrauben-Kit ist nicht im Lieferumfang enthalten.
Siehe Seite 49 um das passende Schrauben-Kit zu bestellen / Kit de tornillería en ergal no incluido. Para incluirlo consultar el apartado kits de tornillería en ergal en la página 49 / La visserie n'est pas inclus. Consultez la section des kit visserie bouchon de réservoir à la page 49

BLOCCHETTI TENDICATENA / AXIAL BLOCKS / KETTENSPANNER / BLOQUES TENSA CADENA / TENDEURS DE CHAINE

BRAND	MODEL	CODE	COLOUR	EURO w/o tax
APRILIA	CAPONORD 1200 NEW	BT-1012	St Dn Ti Rg Cr Eb / /	/
	DORSODURO 750	BT-1002	St Dn Ti Rg Cr Eb / /	60,00
	DORSODURO 1200	BT-1002	St Dn Ti Rg Cr Eb / /	60,00
	RSV4	BT-1002	St Dn Ti Rg Cr Eb / /	60,00
	SHIVER 750	BT-1002	St Dn Ti Rg Cr Eb / /	60,00
	TUONO V4	BT-1002	St Dn Ti Rg Cr Eb / /	60,00
	S 1000 R '15	BT-1102	St Dn Ti Rg Cr Eb / /	60,00
	S 1000 RR '11-'15	BT-1102	St Dn Ti Rg Cr Eb / /	60,00
	S 1000 XR '15	BT-1102	St Dn Ti Rg Cr Eb / /	60,00
	CB 650 F '14-'15	BT-0119	St Dn Ti Rg Cr Eb / /	/
HONDA	CBR 600 RR '05-'15	BT-0101	St Dn Ti Rg Cr Eb / /	60,00
	CBR 1000 RR '04-'07	BT-0101	St Dn Ti Rg Cr Eb / /	60,00
	ER6-N '12-'16	BT-0414	St Dn Ti Rg Cr Eb / /	60,00
	VERSYS 1000 '12 >	BT-0415	St Dn Ti Rg Cr Eb / /	60,00
KAWASAKI	ZX10R '08 - '10	BT-0408	St Dn Ti Rg Cr Eb Or	60,00
	ZX10R '11-'15	BT-0413	St Dn Ti Rg Cr Eb / /	60,00
	625 SMC	BT-0902	St Dn / / / / Or	65,00
	690 DUKE	BT-0900	St Dn / / / / Or	65,00
	690 SMC	BT-0900	St Dn / / / / Or	65,00
KTM	690 SUPERMOTO	BT-0900	St Dn / / / / Or	65,00
	690 SUPERMOTO R	BT-0900	St Dn / / / / Or	65,00
	990 SUPERMOTO	BT-0900	St Dn / / / / Or	65,00

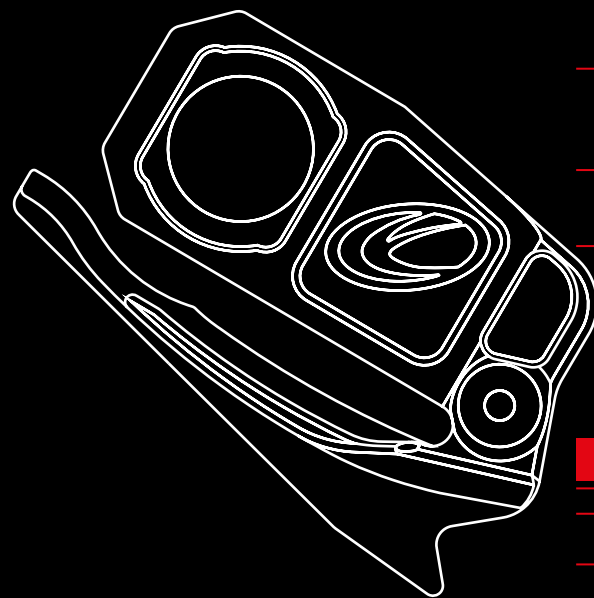
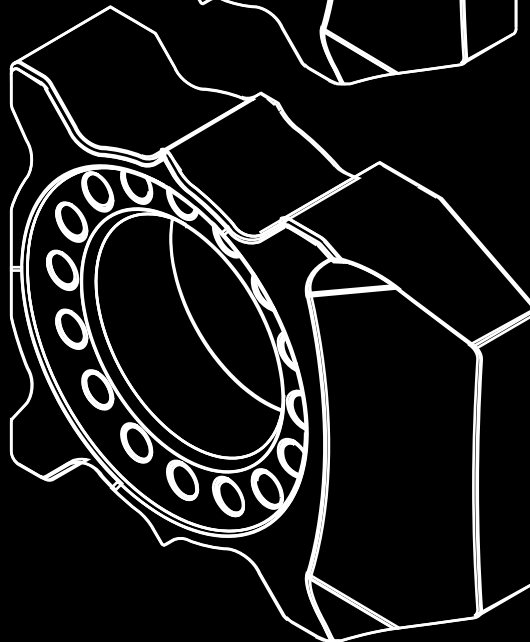
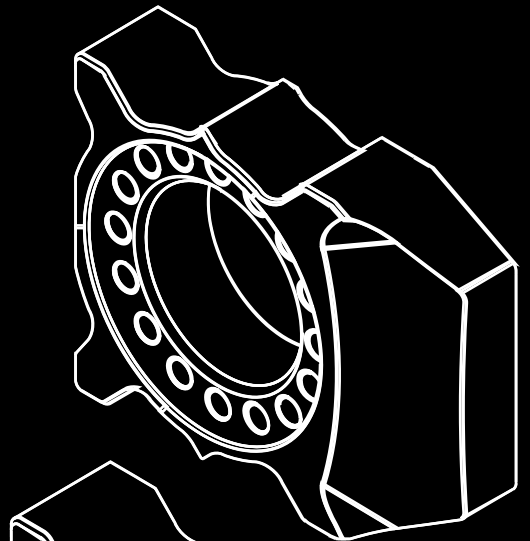
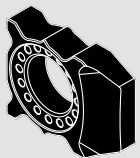

BRAND	MODEL	CODE	COLOUR	EURO w/o tax
KTM	950 SUPERMOTO R	BT-0900	St Dn / / / / Or	65,00
	990 SUPERDUKE R	BT-0900	St Dn / / / / Or	65,00
	1190 RC8	BT-0900	St Dn / / / / Or	65,00
	LC4 640 '03	BT-0902	St Dn / / / / Or	65,00
	OFFROAD COMPETITION 125/200/300	BT-0902	St Dn / / / / Or	65,00
	OFFROAD COMPETITION 400/450/530	BT-0902	St Dn / / / / Or	65,00
	OFFROAD COMPETITION LX 125/150	BT-0902	St Dn / / / / Or	65,00
	OFFROAD COMPETITION LX 250/450	BT-0902	St Dn / / / / Or	65,00
	SUPERMOTO 450 SMR	BT-0902	St Dn / / / / Or	65,00
	GSR 600 '06-'11	BT-0314	St Dn Ti Rg Cr Eb / /	60,00
SUZUKI	GSX-R 1000 '05-'15	BT-0312	St Dn Ti Rg Cr Eb / /	60,00
	GSX-R 600/750 '06-'10	BT-0314	St Dn Ti Rg Cr Eb / /	60,00
	GSX-R 600/750 '11-'15	BT-0314	St Dn Ti Rg Cr Eb / /	60,00
	GSX-S 1000 '15	BT-0312	St Dn Ti Rg Cr Eb / /	60,00
	DAYTONA 675/R	BT-0703	St Dn Ti Rg Cr Eb / /	60,00
	STREET TRIPLE	BT-0703	St Dn Ti Rg Cr Eb / /	60,00
	STREET TRIPLE 675/R '13-'15	BT-0703	St Dn Ti Rg Cr Eb / /	60,00
	Tiger 800	BT-0703	St Dn Ti Rg Cr Eb / /	60,00
	R1 '07-'16	BT-0215	St Dn Ti Rg Cr Eb / /	60,00
	R6 '06-'15	BT-0208*	Vedi "Kit smontaggio rapido ruota posteriore"	/
TMAX '12 >	BT-0215	St Dn Ti Rg Cr Eb / /	60,00	

* Sconto differente
Different discount
Anderer Rabatt
Diferente descuento
Remise différent

BLOCCHETTI TENDICATENA CON SLIDERS / CHAIN ADJUSTERS KIT WITH SHOCK-RESISTANCE SLIDERS TENSORES DE CADENA CON PROTECTORES RESISTENTES A GOLPES / TENDEURS DE CHAÎNE AVEC SLIDER

BRAND	MODEL	CODE	COLOUR	EURO w/o tax
APRILIA	TUONO V4 1100 RR '15	BTS-1005	St Dn Ti Rg Cr Eb / /	/
	GSR 600 '06-'11	BTS-0314	St Dn Ti Rg Cr Eb / /	/
	GSX-R 600/750 '11-'15	BTS-0314	St Dn Ti Rg Cr Eb / /	/

KIT SMONTAGGIO RAPIDO RUOTA POSTERIORE / RAPID WHEEL CHANGE KIT / RAD-SCHNELLWECHSEL-KIT SISTEMA DESMONTAJE RÁPIDO RUEDA TRASERA / KIT SOSTITUTION RAPIDE ROUE ARRIERE

BRAND	MODEL	CODE	COLOUR	EURO w/o tax
YAMAHA	R6 '06-'15	BT-0208 *	/ Dn / / / / /	210,00
		BT-0208-L		
		BT-0208-R		

TAPPO OLIO / OIL FILLER CAP / ÖL-EINFÜLLSCHRAUBEN / TAPÓN LLENADO ACEITE / BOUCHONS D'HUILE

BRAND	APPLICATION	CODE	COLOUR	EURO w/o tax
APRILIA	M 20 x 1,5	OFC-01	St Dn Ti Rg Cr Eb / / /	19,50
	CAPONORD 1200	OFC-01	St Dn Ti Rg Cr Eb / / /	19,50
	DORSODURO 750	OFC-06	St Dn Ti Rg Cr Eb / / /	19,50
	DORSODURO 1200	OFC-01	St Dn Ti Rg Cr Eb / / /	19,50
	RSV4	OFC-06	St Dn Ti Rg Cr Eb / / /	19,50
	SHIVER 750 '07-'12	OFC-06	St Dn Ti Rg Cr Eb / / /	19,50
	TUONO V4	OFC-06	St Dn Ti Rg Cr Eb / / /	19,50
	TUONO V4 1100 RR '15	OFC-06	St Dn Ti Rg Cr Eb / / /	19,50
	M 24 x 1,5	OFC-02	St Dn Ti Rg Cr Eb / / /	19,50
	BN 600	OFC-04	St Dn Ti Rg Cr Eb / / /	19,50
BENELLI	F 800 '13	OFC-09B	St Dn Ti Rg Cr Eb / / /	19,50
	MOTORI BOXER	OFC-12	St Dn / / / Eb / / /	38,00
	S 1000 RR	OFC-11	St Dn Ti Rg Cr Eb / / /	19,50
	S 1000 XR '15	OFC-11	St Dn Ti Rg Cr Eb / / /	19,50
	1098/1098R/1098S TRICOLORE/1198/1198R/1198S/1198S CORSE/1198 SP	OFC-03	St Dn Ti Rg Cr Eb / / Dks	19,50
	HYM1100/1100S/1100EVO/1100EVO SP	OFC-03	St Dn Ti Rg Cr Eb / / Dks	19,50
	M1100/1100ABS/1100S/1100S ABS	OFC-03	St Dn Ti Rg Cr Eb / / Dks	19,50
	MONSTER-MY08, MTS620/1000/1100, STREETFIGHTER/STREETFIGHTER S, SC, 999/749, SS, ST	OFC-03	St Dn Ti Rg Cr Eb / / Dks	19,50
	848/848 EVO/848 EVO CORSE SPECIAL ED., HYM796, M1100 EVO/1100 EVO DIESEL	OFC-04	St Dn Ti Rg Cr Eb / Gr Dks	19,50
	M696/796 all models, MTS1200/1200	OFC-04	St Dn Ti Rg Cr Eb / Gr Dks	19,50
BMW	ABS/1200 SPORT/1200S TOURING/1200S Pikes Peak/1200S GRANTURISMO	OFC-04	St Dn Ti Rg Cr Eb / Gr Dks	19,50
	STREETFIGHTER 848, 1199, 1199 ABS, 1199S, 1199S TRICOLORE, 1199S ABS, DIAVEL, MONSTER 1200/821	OFC-04	St Dn Ti Rg Cr Eb / Gr Dks	19,50
	PANIGALE 1299 '15	OFC-04	St Dn Ti Rg Cr Eb / Gr Dks	19,50
	M 20 x 2,5	OFC-04	St Dn Ti Rg Cr Eb / Gr Dks	19,50
	CB 650 F (All)	OFC-04	St Dn Ti Rg Cr Eb / Gr Dks	19,50
	CB 1000 R (All)	OFC-04	St Dn Ti Rg Cr Eb / Gr Dks	19,50
	CB 1300 (All)	OFC-04	St Dn Ti Rg Cr Eb / Gr Dks	19,50
	CBF 1000 (All)	OFC-04	St Dn Ti Rg Cr Eb / Gr Dks	19,50
	CBF 1000 / ST (All)	OFC-04	St Dn Ti Rg Cr Eb / Gr Dks	19,50
	CBF 600 / N (All)	OFC-04	St Dn Ti Rg Cr Eb / Gr Dks	19,50
DUCATI	CBF 600 / NS (All)	OFC-04	St Dn Ti Rg Cr Eb / Gr Dks	19,50
	CBR 125 (All)	OFC-04	St Dn Ti Rg Cr Eb / Gr Dks	19,50
	CBR 250 CC (All)	OFC-04	St Dn Ti Rg Cr Eb / Gr Dks	19,50
	CBR 600 F (All)	OFC-04	St Dn Ti Rg Cr Eb / Gr Dks	19,50
	CBR 600 RR (All)	OFC-04	St Dn Ti Rg Cr Eb / Gr Dks	19,50
	CBR 900 RR (All)	OFC-04	St Dn Ti Rg Cr Eb / Gr Dks	19,50
	CBR 929 RR (All)	OFC-04	St Dn Ti Rg Cr Eb / Gr Dks	19,50
	CBR 954 RR (All)	OFC-04	St Dn Ti Rg Cr Eb / Gr Dks	19,50
	CBR 1000 RR (from 2004 to 2015)	OFC-04	St Dn Ti Rg Cr Eb / Gr Dks	19,50
	CBR 1100 XX (All)	OFC-04	St Dn Ti Rg Cr Eb / Gr Dks	19,50
HONDA	CBR FIREBLADE (All)	OFC-04	St Dn Ti Rg Cr Eb / Gr Dks	19,50
	CROSSRUNNER	OFC-09B	St Dn Ti Rg Cr Eb / / /	19,50

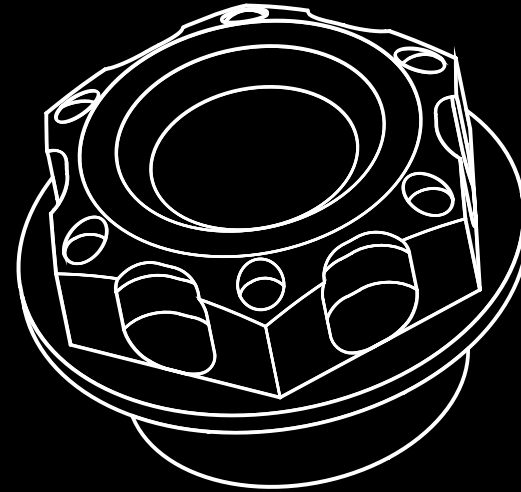

BRAND
HONDA
HUSOVARNA
KAWASAKI
KTM
MV AGUSTA
SUZUKI
TRIUMPH
YAMAHA

APPLICATION	CODE	COLOUR	EURO w/o tax
HORNET 600 / 600 S / 900 (All)	OFC-04	St Dn Ti Rg Cr Eb / Gr Dks	19,50
INTEGRA (All)	OFC-04	St Dn Ti Rg Cr Eb / Gr Dks	19,50
NC 700 / 750 X (All)	OFC-04	St Dn Ti Rg Cr Eb / Gr Dks	19,50
VFR 750 / 800 / 1000 F (All)	OFC-04	St Dn Ti Rg Cr Eb / Gr Dks	19,50
VTR SP1 / VTR SP2 (All)	OFC-04	St Dn Ti Rg Cr Eb / Gr Dks	19,50
NUDA 900	OFC-09B	St Dn Ti Rg Cr Eb / / /	19,50
M 30 x 1,5	OFC-05	St Dn Ti Rg Cr Eb Or Gr /	19,50
ER6-N/F	OFC-04	St Dn Ti Rg Cr Eb / Gr Dks	19,50
KLV	OFC-01	St Dn Ti Rg Cr Eb / / /	19,50
KX 125 '00-'14	OFC-04	St Dn Ti Rg Cr Eb / Gr Dks	19,50
VERSYS	OFC-04	St Dn Ti Rg Cr Eb / Gr Dks	19,50
Z 250 '15	OFC-05	St Dn Ti Rg Cr Eb Or Gr Dks	19,50
Z 1000 '10-'16	OFC-04	St Dn Ti Rg Cr Eb / Gr Dks	19,50
Z 1000 SX '11-'16	OFC-04	St Dn Ti Rg Cr Eb / Gr Dks	19,50
Z 800 '13-'16	OFC-04	St Dn Ti Rg Cr Eb / Gr Dks	19,50
M 24X3	OFC-09	St Dn / / / / Or / /	19,50
690 SMC/ENDURO/R, 690 SUPERMOTO R	OFC-09	St Dn / / / / Or / /	19,50
950 ADVENTURE, LC4 640, MOTORI LC4/LC8	OFC-09	St Dn / / / / Or / /	19,50
1190 RC8, 125-530, 625 SMC, 690 DUKE	OFC-09	St Dn / / / / Or / /	19,50
DUKE 125/200/390 '14 RX SIDE	OFC-13	St Dn / / / / Or / / /	/
DUKE 125/200/390 '14 LX SIDE	OFC-14	St Dn / / / / Or / / /	/
OFFROAD COMPETITION / LX,	OFC-09	St Dn / / / / Or / / /	19,50
R 1290 SUPERDUKE, RC 125	OFC-09	St Dn / / / / Or / / /	19,50
SUPERDUKE 990/R, SUPERMOTO 450 SMR	OFC-09	St Dn / / / / Or / / /	19,50
M 25 x 1,5	OFC-06	St Dn Ti Rg Cr Eb / / /	19,50
BRUTALE 675	OFC-09B	St Dn Ti Rg Cr Eb / / /	19,50
BRUTALE 750	OFC-06	St Dn Ti Rg Cr Eb / / /	19,50
BRUTALE 800	OFC-09B	St Dn Ti Rg Cr Eb / / /	19,50
BRUTALE 910/S/R	OFC-06	St Dn Ti Rg Cr Eb / / /	19,50
BRUTALE 990	OFC-06	St Dn Ti Rg Cr Eb / / /	19,50
BRUTALE 1078	OFC-06	St Dn Ti Rg Cr Eb / / /	19,50
BRUTALE 1090	OFC-06	St Dn Ti Rg Cr Eb / / /	19,50
DRAGSTER	OFC-09B	St Dn Ti Rg Cr Eb / / /	19,50
F3	OFC-09C	St Dn Ti Rg Cr Eb / / /	19,50
RIVALE	OFC-09B	St Dn Ti Rg Cr Eb / / /	19,50
M 20 x 1,5	OFC-01	St Dn Ti Rg Cr Eb / / /	19,50
M 20 x 2,5	OFC-08	St Dn Ti Rg Cr Eb / / /	19,50
DAYTONA 675/R '13-'14	OFC-04	St Dn Ti Rg Cr Eb / Gr Dks	19,50
STREET TRIPLE 675/R	OFC-04	St Dn Ti Rg Cr Eb / Gr Dks	19,50
M 26 x 3	OFC-07	St Dn Ti Rg Cr Eb / / /	19,50
MT-03	OFC-04	St Dn Ti Rg Cr Eb / Gr Dks	19,50
MT-07	OFC-07	St Dn Ti Rg Cr Eb / / /	19,50
MT-09/TRACER	OFC-04	St Dn Ti Rg Cr Eb / Gr Dks	19,50
R3 '15	OFC-07	St Dn Ti Rg Cr Eb / Gr Dks	19,50
T-MAX	OFC-04	St Dn Ti Rg Cr Eb / Gr Dks	19,50
WR 125/250 '00 >	OFC-04	St Dn Ti Rg Cr Eb / Gr Dks	19,50
WRF 250/450 '00 >	OFC-04	St Dn Ti Rg Cr Eb / Gr Dks	19,50
YZ 125/250 '00 >	OFC-04	St Dn Ti Rg Cr Eb / Gr Dks	19,50
YZF 250/450 '00 >	OFC-04	St Dn Ti Rg Cr Eb / Gr Dks	19,50
YZF-R125 '14-'16	OFC-04*	St Dn Ti Rg Cr Eb / Gr Dks	19,50

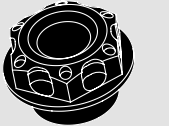

*
 IT Senza Asta
 EN Without shaft
 DE
 ES Sin medidor de nivel
 FR Sans jauge

**THUNDERBOLT (DADI RUOTA ANTERIORE / FRONT AXLE NUT / ACHSMUTTER-VORDERRAD
TORNILLO - TUERCA EJE DELANTERO / ECROU ROUE AVANT)**

BRAND	MODEL	YEAR	CODE	COLOUR	EURO w/o tax
APRILIA	CAPONORD 1200	'13	TB-018	St Dn Ti Rg Cr Eb	22,00
	DORSODURO 750	'08-'11	TB-018	St Dn Ti Rg Cr Eb	22,00
	DORSODURO 1200	'11-'15	TB-018	St Dn Ti Rg Cr Eb	22,00
	RS 125	'08-'09	TB-018	St Dn Ti Rg Cr Eb	22,00
	RSV 1000 R / FACTORY	'02-'11	TB-018	St Dn Ti Rg Cr Eb	22,00
	RSV4 / TUONO R / FACTORY	'02-'14	TB-018	St Dn Ti Rg Cr Eb	22,00
	SHIVER 750	'08-'10	TB-018	St Dn Ti Rg Cr Eb	22,00
	TUONO V4	'11-'14	TB-018	St Dn Ti Rg Cr Eb	22,00
	TUONO V4 1100 RR NEW	'15	TB-029	St Dn Ti Rg Cr Eb	/
	S 1000 XR	'15	TB-066	St Dn Ti Rg Cr Eb	22,00
	MONSTER 821 NEW	'15	TB-064	St Dn Ti Rg Cr Eb	/
	MONSTER 1200 NEW	'15	TB-064	St Dn Ti Rg Cr Eb	/
SCRAMBLER NEW	'15	TB-027	St Dn Ti Rg Cr Eb	/	
HONDA	CB 650 F	'14 >	TB-060	St Dn Ti Rg Cr Eb	22,00
	CB 1000 R	'08-'14	TB-060	St Dn Ti Rg Cr Eb	22,00
	CBR 600 F	'11-'13	TB-060	St Dn Ti Rg Cr Eb	22,00
	CBR 600 F / SPORT	'99-'06	TB-060	St Dn Ti Rg Cr Eb	22,00
	CBR 600 RR	'03-'15	TB-060	St Dn Ti Rg Cr Eb	22,00
	CBR 929 / 954 RR	'00-'03	TB-061	St Dn Ti Rg Cr Eb	22,00
	CBR 1000 RR	'04-'15	TB-061	St Dn Ti Rg Cr Eb	22,00
	CROSSRUNNER	'11 >	TB-060	St Dn Ti Rg Cr Eb	22,00
	HORNET 600	'98-'13	TB-060	St Dn Ti Rg Cr Eb	22,00
	HORNET 900	'02-'07	TB-060	St Dn Ti Rg Cr Eb	22,00
	VTR SP1 / SP2	/	TB-060	St Dn Ti Rg Cr Eb	22,00
	Z 250	'15	TB-016	St Dn Ti Rg Cr Eb	22,00
ZX 10R	'06-'10	TB-005	St Dn Ti Rg Cr Eb	22,00	
ER6N	'06-'08	TB-061	St Dn Ti Rg Cr Eb	22,00	
MV AGUSTA	BRUTALE 675/800 NEW	/	TB-063	St Dn Ti Rg Cr Eb	/
	GSX-R 600 / 750	'06-'10	TB-061	St Dn Ti Rg Cr Eb	22,00
SUZUKI	GSX-R 600 / 750	'11-'15	TB-002	St Dn Ti Rg Cr Eb	22,00
	GSX-R 1000	'05-'14	TB-061	St Dn Ti Rg Cr Eb	22,00
	BANDIT 1200 / S	'06-'07	TB-061	St Dn Ti Rg Cr Eb	22,00
	B-KING	'08-'12	TB-061	St Dn Ti Rg Cr Eb	22,00
	HAYABUSA	'09 >	TB-061	St Dn Ti Rg Cr Eb	22,00
	R1	'02-'14	TB-060	St Dn Ti Rg Cr Eb	22,00
YAMAHA	R1	'15-'16	TB-004	St Dn Ti Rg Cr Eb	22,00
	R3	'15	TB-016	St Dn Ti Rg Cr Eb	22,00
	R6	'05-'15	TB-060	St Dn Ti Rg Cr Eb	22,00

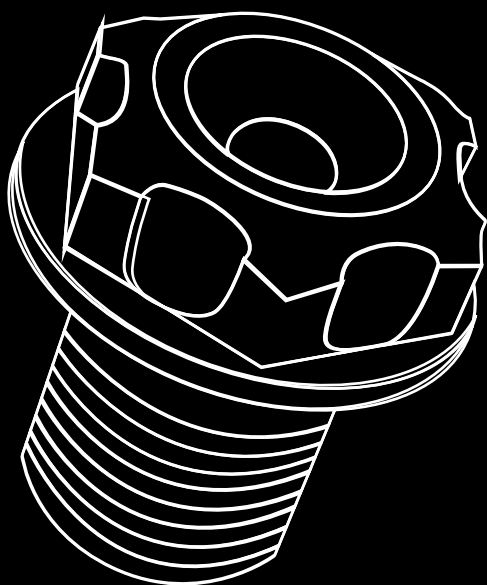

**THUNDERBOLT (DADI RUOTA POSTERIORE / REAR AXLE NUT / ACHSMUTTER-HINTERRAD
TUERCA EJE TRASERO / ECROU AXE DE ROUE AR)**

BRAND	MODEL	YEAR	CODE	COLOUR	EURO w/o tax
APRILIA	CAPONORD 1200	'13 >	TB-018	St Dn Ti Rg Cr Eb /	22,00
	DORSODURO 750	'08-'15	TB-018	St Dn Ti Rg Cr Eb /	22,00
	DORSODURO 1002	'11 >	TB-018	St Dn Ti Rg Cr Eb /	22,00
	RS 125	'08-'09	TB-018	St Dn Ti Rg Cr Eb /	22,00
	RSV 1000 R / RSV4	'02-'14	TB-018	St Dn Ti Rg Cr Eb /	22,00
	SHIVER 750	'08-'15	TB-018	St Dn Ti Rg Cr Eb /	22,00
	TUONO V4	'11 >	TB-018	St Dn Ti Rg Cr Eb /	22,00
	TUONO V4 1100 RR	'15	TB-018	St Dn Ti Rg Cr Eb /	22,00
	TUONO R / FACTORY	'02-'11	TB-018	St Dn Ti Rg Cr Eb /	22,00
	BN 600	'15	TB-005	St Dn Ti Rg Cr Eb /	28,60
	F800	'13	TB-017	St Dn Ti Rg Cr Eb /	22,00
	S 1000 R	'15	TB-005	St Dn Ti Rg Cr Eb /	22,00
S 1000 RR	'10-'15	TB-005	St Dn Ti Rg Cr Eb /	22,00	
S 1000 XR	'15	TB-005	St Dn Ti Rg Cr Eb /	22,00	
749 / 999	'02-'06	TB-002	St Dn Ti Rg Cr Eb /	22,00	
1198 / 1098 / 848	/	TB-025	St Dn / Rg Cr / / /	/	
DIAVEL	/	TB-014	St Dn Ti Rg Cr Eb /	38,00	
MONSTER 821 (LX-RX) NEW	/	TB-030	St Dn Ti Rg Cr Eb /	/	
MONSTER 1200	/	TB-014	St Dn Ti Rg Cr Eb /	38,00	
MONSTER S4 NEW	/	TB-007	St Dn / Rg Cr / / /	38,00	
MULTISTRADA 1200	'15	TB-014	St Dn Ti Rg Cr Eb /	38,00	
PANIGALE 899 NEW	/	TB-026	St Dn Ti Rg Cr Eb /	/	
PANIGALE 1199 / 1299	'12 >	TB-014	St Dn Ti Rg Cr Eb /	38,00	
SCRAMBLER (LX-RX) NEW	/	TB-028	St Dn Ti Rg Cr Eb /	/	
CB 650F	'14 >	TB-001	St Dn Ti Rg Cr Eb /	22,00	
CBR 600 F	'99-'06	TB-001	St Dn Ti Rg Cr Eb /	22,00	
CBR 600 F	'11-'13	TB-001	St Dn Ti Rg Cr Eb /	22,00	
CBR 600 RR	'03-'15	TB-003	St Dn Ti Rg Cr Eb /	22,00	
CBR 929 / 954 RR	'00-'03	TB-003	St Dn Ti Rg Cr Eb /	22,00	
CBR 1000 RR	'04-'15	TB-003	St Dn Ti Rg Cr Eb /	22,00	
HORNET 600	'98-'06	TB-017	St Dn Ti Rg Cr Eb /	22,00	
HORNET 600	'07-'13	TB-001	St Dn Ti Rg Cr Eb /	22,00	
HORNET 900	'02-'07	TB-001	St Dn Ti Rg Cr Eb /	22,00	
INTEGRA / NC 700 X	'12 >	TB-001	St Dn Ti Rg Cr Eb /	22,00	
VTR SP1 - SP2	/	TB-003	St Dn Ti Rg Cr Eb /	22,00	
NUDA 900	'12 >	TB-017	St Dn Ti Rg Cr Eb /	22,00	
ER6-N / F	'06-'16	TB-001	St Dn Ti Rg Cr Eb /	22,00	
VERSYS	'06-'14	TB-001	St Dn Ti Rg Cr Eb /	22,00	
Z 250	'15	TB-017	St Dn Ti Rg Cr Eb /	22,00	
Z 750 / S	'04 >	TB-001	St Dn Ti Rg Cr Eb /	22,00	
Z 800	'13-'16	TB-001	St Dn Ti Rg Cr Eb /	22,00	
Z 1000	'03-'16	TB-005	St Dn Ti Rg Cr Eb /	22,00	
ZX 6R / RR	'03-'15	TB-005	St Dn Ti Rg Cr Eb /	22,00	
ZX 10R	'04-'10	TB-001	St Dn Ti Rg Cr Eb /	22,00	
ZX 10R	'11-'15	TB-005	St Dn Ti Rg Cr Eb /	22,00	
125 - 530	/	TB-002	St Dn Ti Rg Cr Eb /	22,00	
690 DUKE	'12-'15	TB-018	St Dn Ti Rg Cr Eb /	22,00	

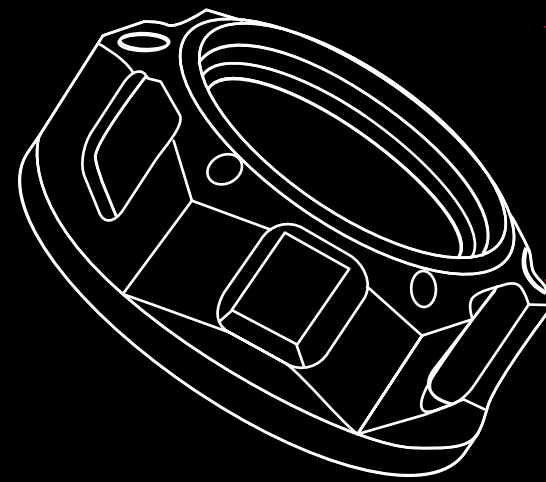

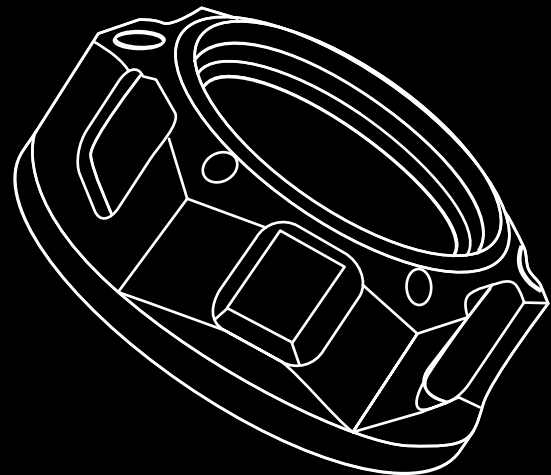

BRAND	MODEL	YEAR	CODE	COLOUR	EURO w/o tax
KTM	1290 SUPERDUKE R	'14>	TB-024	St Dn / Rg / / Or	45,00
	DUKE 125	/	TB-016	St Dn Ti Rg Cr Eb /	22,00
	DUKE 390	/	TB-016	St Dn Ti Rg Cr Eb /	22,00
	LC8 / LC4	/	TB-018	St Dn Ti Rg Cr Eb /	22,00
MV AGUSTA	Tutti / All / Alle / Todos / Tous	/	TB-006	St Dn Ti Rg Cr / /	50,00
	BANDIT 1200/S	'05-'08	TB-008	St Dn Ti Rg Cr Eb /	22,00
	B-KING	'08-'12	TB-008	St Dn Ti Rg Cr Eb /	22,00
	GLADIUS	/	TB-002	St Dn Ti Rg Cr Eb /	22,00
SUZUKI	GSR 600	'06-'11	TB-003	St Dn Ti Rg Cr Eb /	22,00
	GSR 750	'11-'15	TB-003	St Dn Ti Rg Cr Eb /	22,00
	GSX-R 600/750	'00-'10	TB-008	St Dn Ti Rg Cr Eb /	22,00
	GSX-R 600/750	'11-'15	TB-003	St Dn Ti Rg Cr Eb /	22,00
	GSX-R 1000	'00-'15	TB-008	St Dn Ti Rg Cr Eb /	22,00
	GSX S 1000	'15	TB-008	St Dn Ti Rg Cr Eb /	22,00
	HAYABUSA	'99-'15	TB-008	St Dn Ti Rg Cr Eb /	22,00
	SV 650/S	'00-'14	TB-001	St Dn Ti Rg Cr Eb /	22,00
	SV 1000/S	'04-'13	TB-008	St Dn Ti Rg Cr Eb /	22,00
	DAYTONA 675/R	'06-'15	TB-001	St Dn Ti Rg Cr Eb /	22,00
	SPEED TRIPLE	'11-'14	TB-012	St Dn Ti Rg Cr Eb /	22,00
	STREET TRIPLE	'07-'12	TB-001	St Dn Ti Rg Cr Eb /	22,00
TRIUMPH	STREET TRIPLE 675/R	'13	TB-001	St Dn Ti Rg Cr Eb /	22,00
	FAZER 600	'98-'03	TB-001	St Dn Ti Rg Cr Eb /	22,00
	FAZER 1000	'01-'05	TB-005	St Dn Ti Rg Cr Eb /	22,00
	FZ1 / FAZER	'06>	TB-005	St Dn Ti Rg Cr Eb /	22,00
	FZ6 / FAZER / S2	'04-'09	TB-005	St Dn Ti Rg Cr Eb /	22,00
	FZ8	'06>	TB-005	St Dn Ti Rg Cr Eb /	22,00
	MT-01	'05-'06	TB-005	St Dn Ti Rg Cr Eb /	22,00
	MT-07	'14>	TB-001	St Dn Ti Rg Cr Eb /	22,00
	MT-09/TRACER	'14>	TB-001	St Dn Ti Rg Cr Eb /	22,00
	R1	'15	TB-005	St Dn Ti Rg Cr Eb /	22,00
	R1	'98-'08	TB-005	St Dn Ti Rg Cr Eb /	22,00
	R1	'09-'16	TB-015	St Dn Ti Rg Cr Eb /	22,00
	R3	'15	TB-017	St Dn Ti Rg Cr Eb /	22,00
	R6	'99-'14	TB-005	St Dn Ti Rg Cr Eb /	22,00
	TMAX 530	'12 >	TB-005	St Dn Ti Rg Cr Eb /	22,00
	XJ6	'09 >	TB-017	St Dn Ti Rg Cr Eb /	22,00
YZF-R125	'14-'16	TB-016	St Dn Ti Rg Cr Eb /	22,00	

YAMAHA

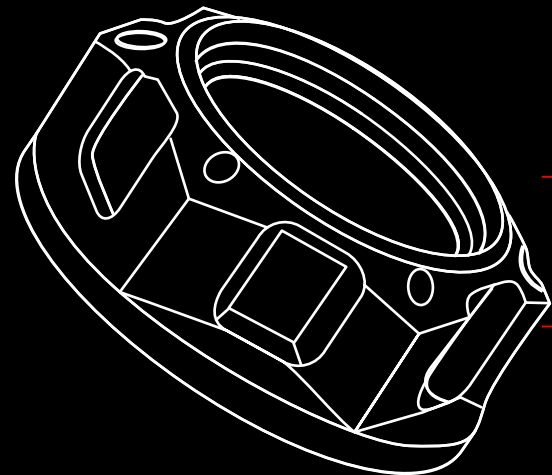

BRAND	MODEL	YEAR	CODE	COLOUR	EURO w/o tax
APRILIA	CAPONORD 1200	'13	TB-002	St Dn Ti Rg Cr Eb	22,00
	DORSODURO 750	'08>	TB-002	St Dn Ti Rg Cr Eb	22,00
	SHIVER 750	'08>	TB-002	St Dn Ti Rg Cr Eb	22,00
	RSV 1000/TUONO / RSV4	/	TB-002	St Dn Ti Rg Cr Eb	22,00
BENELLI	TUONO V4 1100 RR	'15	TB-002	St Dn Ti Rg Cr Eb	22,00
	TNT/TORNADO	/	TB-061	St Dn Ti Rg Cr Eb	22,00
	S 1000 R	'15	TB-001	St Dn Ti Rg Cr Eb	22,00
	S 1000 RR	'10-'15	TB-001	St Dn Ti Rg Cr Eb	22,00
BMW	S 1000 XR	'15	TB-001	St Dn Ti Rg Cr Eb	22,00
	MONTER 821/1200	/	TB-065	St Dn Ti Rg Cr Eb	/
	CB 650 F	'14>	TB-001	St Dn Ti Rg Cr Eb	22,00
	CB 1000 R	'08-'15	TB-001	St Dn Ti Rg Cr Eb	22,00
DUCATI	CBR 600 F	'11-'13	TB-001	St Dn Ti Rg Cr Eb	22,00
	CBR 600 F/SPORT	'99-'06	TB-001	St Dn Ti Rg Cr Eb	22,00
	CBR 600 RR	'07-'15	TB-001	St Dn Ti Rg Cr Eb	22,00
	CBR 1000 RR	'04-'15	TB-003	St Dn Ti Rg Cr Eb	22,00
	HORNET 600	'98-'06	TB-016	St Dn Ti Rg Cr Eb	22,00
	HORNET 600	'07-'13	TB-001	St Dn Ti Rg Cr Eb	22,00
	VTR SP1	/	TB-003	St Dn Ti Rg Cr Eb	22,00
	VTR SP2	/	TB-001	St Dn Ti Rg Cr Eb	22,00
	DUKE 390	'14>	TB-016	St Dn Ti Rg Cr Eb	22,00
	VERSYS 1000	'12 >	TB-002	St Dn Ti Rg Cr Eb	22,00
	Z 800	'13-'16	TB-002	St Dn Ti Rg Cr Eb	22,00
	Z 1000	'10-'16	TB-002	St Dn Ti Rg Cr Eb	22,00
HONDA	ZX 6R/RR	'03-'15	TB-002	St Dn Ti Rg Cr Eb	22,00
	ZX 10R	'04-'10	TB-002	St Dn Ti Rg Cr Eb	22,00
	B-KING	'08-'12	TB-002	St Dn Ti Rg Cr Eb	22,00
	GSX-R 600/750	'00-'03	TB-008	St Dn Ti Rg Cr Eb	22,00
	GSX-R 600/750	'04-'15	TB-002	St Dn Ti Rg Cr Eb	22,00
	GSX-R 1000	'01-'04	TB-008	St Dn Ti Rg Cr Eb	22,00
	GSX-R 1000	'05-'15	TB-002	St Dn Ti Rg Cr Eb	22,00
	HAYABUSA	'99-'15	TB-008	St Dn Ti Rg Cr Eb	22,00
	SV 650/S	'00-'14	TB-001	St Dn Ti Rg Cr Eb	22,00
	SV 1000/S	'04-'14	TB-008	St Dn Ti Rg Cr Eb	22,00
	DAYTONA 675/R	'06-'15	TB-017	St Dn Ti Rg Cr Eb	22,00
	STREET TRIPLE 675/R	'07-'15	TB-017	St Dn Ti Rg Cr Eb	22,00
KAWASAKI	FAZER 600	'98-'03	TB-001	St Dn Ti Rg Cr Eb	22,00
	FZ1 / FAZER	'06>	TB-001	St Dn Ti Rg Cr Eb	22,00
	FZ6 / FAZER / S2	'04-'15	TB-001	St Dn Ti Rg Cr Eb	22,00
	FZ8	'10>	TB-001	St Dn Ti Rg Cr Eb	22,00
	MT-03	'06>	TB-017	St Dn Ti Rg Cr Eb	22,00
	MT-09	'14>	TB-001	St Dn Ti Rg Cr Eb	22,00
	R1	'98-'06	TB-001	St Dn Ti Rg Cr Eb	22,00
	R1 (LX Dado / Left nut / Achsmutter / Tuerca / Écrou)	'07-'16	TB-002	St Dn Ti Rg Cr Eb	22,00
	R1 (RX Ghiera / Ring nut / Ringmutter / Anillo / Anneu)	'07-'16	TB-020	St Dn Ti / / Eb	22,00
	R6	'99-'05	TB-001	St Dn Ti Rg Cr Eb	22,00
	R6 (LX Dado / Left nut / Achsmutter / Tuerca / Écrou)	'06-'15	TB-003	St Dn Ti Rg Cr Eb	22,00
	R6 (RX Ghiera / Ring nut / Ringmutter / Anillo / Anneu)	'06-'15	TB-011	St Dn Ti Rg Cr Eb	22,00

KAWASAKI

SUZUKI

TRIUMPH

YAMAHA

THUNDERBOLT (DADO FORCELLONE / SWINGARM NUT / ACHSMUTTER-SCHWINGE
TUERCA EJE BASCULANTE / ECROU AXE DE BRAS OSCILLANT)

**THUNDERBOLT (DADO CANOTTO DI STERZO / TOP YOKE NUT / GABELBRÜCKENMUTTER
TUERCA EJE DIRECCIÓN / ECROU COLONNE DE DIRECTION)**

BRAND	MODEL	YEAR	CODE	COLOUR	EURO w/o tax
APRILIA	DORSODURO 750/SHIVER 750	'08>	TB-010	St Dn Ti Rg Cr Eb	22,00
	R NINE T	'14>	TB-009	St Dn Ti Rg Cr Eb	22,00
BMW	S 1000 R	'15	TB-009	St Dn Ti Rg Cr Eb	22,00
	S 1000 RR	'10-'15	TB-009	St Dn Ti Rg Cr Eb	22,00
DUCATI	PANIGALE 899 / 1199 / 1299	/	TB-022	St Dn Ti Rg Cr Eb	/
	CB 650F	'14>	TB-004	St Dn Ti Rg Cr Eb	22,00
HONDA	CBR125	'11>	TB-004	St Dn Ti Rg Cr Eb	22,00
	CBR 600 F	'99-'06	TB-004	St Dn Ti Rg Cr Eb	22,00
	CBR 600 F	'11-'13	TB-004	St Dn Ti Rg Cr Eb	22,00
	CBR 600 RR	'03-'15	TB-004	St Dn Ti Rg Cr Eb	22,00
	CBR 900 RR	'00-'03	TB-004	St Dn Ti Rg Cr Eb	22,00
	CBR1000RR	'08-'11	TB-019	St Dn Ti Rg Cr Eb	22,00
	CBR1000RR	'12-'15	TB-004	St Dn Ti Rg Cr Eb	22,00
	HORNET 600	'98-'13	TB-004	St Dn Ti Rg Cr Eb	22,00
	HORNET 900	'02-'07	TB-004	St Dn Ti Rg Cr Eb	22,00
	VTR SP1	/	TB-004	St Dn Ti Rg Cr Eb	22,00
	ZX 6R/RR	'05-'15	TB-009	St Dn Ti Rg Cr Eb	22,00
	ZX10R	'04-'07	TB-009	St Dn Ti Rg Cr Eb	22,00
KAWASAKI	DUKE 390	'14>	/	St Dn Ti Rg Cr / /	/
	B 675/800 BRUTALE	/	/	St Dn Ti Rg Cr / /	/
KTM	DRAGSTER 800	/	/	St Dn Ti Rg Cr / /	/
	F3	/	/	St Dn Ti Rg Cr / /	/
MV AGUSTA	BANDIT 650/S	'06-'15	TB-015	St Dn Ti Rg Cr Eb	22,00
	B-KING	'08-'12	TB-015	St Dn Ti Rg Cr Eb	22,00
	HAYABUSA	/	TB-015	St Dn Ti Rg Cr Eb	22,00
	GSR 600 NAKED	'06-'11	TB-015	St Dn Ti Rg Cr Eb	22,00
	GSR 750	'11-'15	TB-010	St Dn Ti Rg Cr Eb	22,00
	GSX-R 600/750	'96-'05	TB-015	St Dn Ti Rg Cr Eb	22,00
	GSX-R 600/750	'06-'15	TB-009	St Dn Ti Rg Cr Eb	22,00
	GSX-R 1000	'00-'02	TB-015	St Dn Ti Rg Cr Eb	22,00
	GSX-R 1000	'03-'15	TB-009	St Dn Ti Rg Cr Eb	22,00
	SV 650/S	'00-'02	TB-010	St Dn Ti Rg Cr Eb	22,00
	SV 650/S	'03-'14	TB-015	St Dn Ti Rg Cr Eb	22,00
	SV 1000/S	'04-'14	TB-015	St Dn Ti Rg Cr Eb	22,00
	DAYTONA 675/R	'11-'15	TB-021	St Dn Ti Rg Cr Eb	22,00
	SPEED TRIPLE/R	'12-'15	TB-013	St Dn Ti Rg Cr Eb	22,00
	STREET TRIPLE 675/R	'11-'15	TB-021	St Dn Ti Rg Cr Eb	22,00
	FAZER 600	'98-'03	TB-010	St Dn Ti Rg Cr Eb	22,00
	FAZER 1000	'01-'05	TB-010	St Dn Ti Rg Cr Eb	22,00
	FZ1 N/FAZER	'06>	TB-009	St Dn Ti Rg Cr Eb	22,00
FZ6/FAZER	'04-'09	TB-010	St Dn Ti Rg Cr Eb	22,00	
SUZUKI	FZ8	<'12	TB-010	St Dn Ti Rg Cr Eb	22,00
	FZ8	'13>	TB-009	St Dn Ti Rg Cr Eb	22,00
	MT-03	'06>	TB-010	St Dn Ti Rg Cr Eb	22,00
	R1	'98-'15	TB-009	St Dn Ti Rg Cr Eb	22,00
	R6	'99-'15	TB-009	St Dn Ti Rg Cr Eb	22,00
	XJ6	'09>	TB-010	St Dn Ti Rg Cr Eb	22,00
	YZF-R125	'14-'16	TB-010	St Dn Ti Rg Cr Eb	22,00

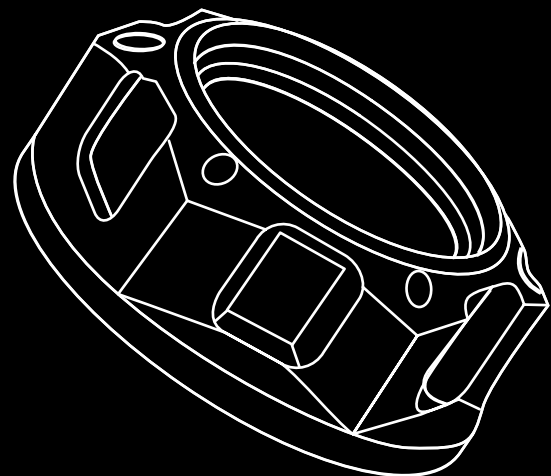

**THUNDERBOLT (DADO PORTA CORONA / SPROCKET CARRIER NUT / RITZELMUTTER
TUERCA PORTA CORONA / ECROU PORTE COURONNE)**

BRAND	MODEL	YEAR	CODE	COLOUR	EURO w/o tax
DUCATI	748	/	TB-007	St Dn / Rg Cr / /	38,00
	848	/	TB-014	St Dn Ti Rg Cr Eb / /	38,00
	916 / 996 / 998	/	TB-007	St Dn / Rg Cr / /	38,00
	1098	/	TB-014	St Dn Ti Rg Cr Eb / /	38,00
	1198	'10-'11	TB-014	St Dn Ti Rg Cr Eb / /	38,00
	DIAVEL	/	TB-014	St Dn Ti Rg Cr Eb / /	38,00
	HYPERMOTARD	/	TB-007	St Dn / Rg Cr / /	38,00
	HYPERSTRADA	/	TB-007	St Dn / Rg Cr / /	38,00
	MTS 1200	'10-'15	TB-014	St Dn Ti Rg Cr Eb / /	38,00
	MTS 1200	'15	TB-014	St Dn Ti Rg Cr Eb / /	38,00
	MONSTER 1100 EVO	/	TB-007	St Dn / Rg Cr / /	38,00
	MONSTER 1200	/	TB-014	St Dn Ti Rg Cr Eb / /	38,00
	MONSTER S2R/S4/R	/	TB-007	St Dn / Rg Cr / /	38,00
	MTS 1000/1100	/	TB-007	St Dn / Rg Cr / /	38,00
	ST 2 / ST 4	/	TB-007	St Dn / Rg Cr / /	38,00
	STREET FIGHTER	'10-'14	TB-014	St Dn Ti Rg Cr Eb / /	38,00
	BRUTALE 1078	/	TB-014	St Dn Ti Rg Cr Eb / /	38,00
	BRUTALE 1090	/	TB-014	St Dn Ti Rg Cr Eb / /	38,00
	BRUTALE 675	/	TB-014	St Dn Ti Rg Cr Eb / /	38,00
	BRUTALE 750	/	TB-014	St Dn Ti Rg Cr Eb / /	38,00
	BRUTALE 800	/	TB-014	St Dn Ti Rg Cr Eb / /	38,00
	BRUTALE 910 / R / S	/	TB-014	St Dn Ti Rg Cr Eb / /	38,00
	BRUTALE 990 R	/	TB-014	St Dn Ti Rg Cr Eb / /	38,00
	DRAGSTER 800	/	TB-014	St Dn Ti Rg Cr Eb / /	38,00
	F3	/	TB-014	St Dn Ti Rg Cr Eb / /	38,00
	RIVALE 800	/	TB-014	St Dn Ti Rg Cr Eb / /	38,00
	R 1290 SUPERDUKE	'14>	TB-023	St Dn / Rg / / Or	38,00

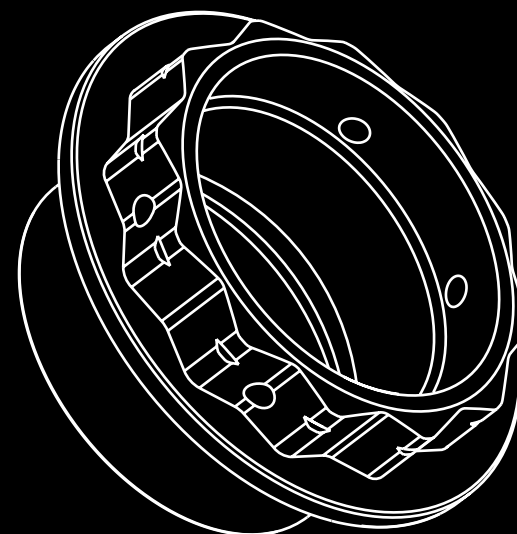

PORTACORONA / SPROCKET CARRIER / RITZEL / PORTACORONA / PORTE COURONNE

BRAND	MODEL	YEAR	CODE	COLOUR	EURO w/o tax
DUCATI	1098 *	/	PCOR-DU-01	St Dn / Rg Cr / /	140,00
	1198 *	/	PCOR-DU-01	St Dn / Rg Cr / /	140,00
	DIAVEL *	/	PCOR-DU-01	St Dn / Rg Cr / /	140,00
	MULTISTRADA 1200 *	'15	PCOR-DU-01	St Dn / Rg Cr / /	140,00
	STREETFIGHTER *	/	PCOR-DU-01	St Dn / Rg Cr / /	140,00
	PANIGALE 1199/899 *	'12-'14	PCOR-DU-01	St Dn / Rg Cr / /	140,00
	UNDER CONSTRUCTION	/	PCOR-MV-01	St Dn / Rg Cr / /	140,00
	UNDER CONSTRUCTION	/	PCOR-MV-01	St Dn / Rg Cr / /	140,00

* 6 fori / 6 holes model / 6 Löcher / 6 agujeros / 6 trous

VITERIA IN ERGAL SFUSA / ERGAL BOLTS / DURALUMINIUM SCHRAUBEN
TORNILLERÍA EN ERGAL / VISSERIE EN ERGAL

TCBEI

MODEL	CODE	COLOUR	EURO w/o tax
M4X10	TCBEI	Si Dn Rg Cr Eb	1,65
M4X15	TCBEI	Si Dn Rg Cr Eb	1,75
M5X10	TCBEI	Si Dn Rg Cr Eb	1,65
M5X15	TCBEI	Si Dn Rg Cr Eb	1,75
M5X20	TCBEI	Si Dn Rg Cr Eb	1,80
M5X25	TCBEI	Si Dn Rg Cr Eb	1,90
M5X30	TCBEI	Si Dn Rg Cr Eb	2,00
M5X35	TCBEI	Si Dn Rg Cr Eb	2,05
M5X40	TCBEI	Si Dn Rg Cr Eb	2,20
M6X10	TCBEI	Si Dn Rg Cr Eb	1,80
M6X15	TCBEI	Si Dn Rg Cr Eb	1,85
M6X20	TCBEI	Si Dn Rg Cr Eb	1,90
M6X25	TCBEI	Si Dn Rg Cr Eb	1,95
M6X30	TCBEI	Si Dn Rg Cr Eb	2,00
M6X35	TCBEI	Si Dn Rg Cr Eb	2,10
M6X40	TCBEI	Si Dn Rg Cr Eb	2,20
M6X45	TCBEI	Si Dn Rg Cr Eb	2,50
M6X50	TCBEI	Si Dn Rg Cr Eb	2,60
M6X55	TCBEI	Si Dn Rg Cr Eb	2,70



VITERIA CONCORRENZA
 COMPETITORS BOLT
 SCHRAUBEN DER WETTBEWERBER
 TORNILLERÍA DE OTROS FABRICANTES
 VISSERIE DES CONCURRENTS

VITERIA EVOTECH
 EVOTECH BOLT
 EVOTECH SCHRAUBEN
 TORNILLERÍA EVOTECH
 VISSERIE EVOTECH

Foro esagonale incrementato del 25%
Hexagonal hole increased of 25%
 25% Tieferer Innensechskant
Profundidad del hexágono incrementada en un 25%
 Hexagonal trou augmenté du 25%

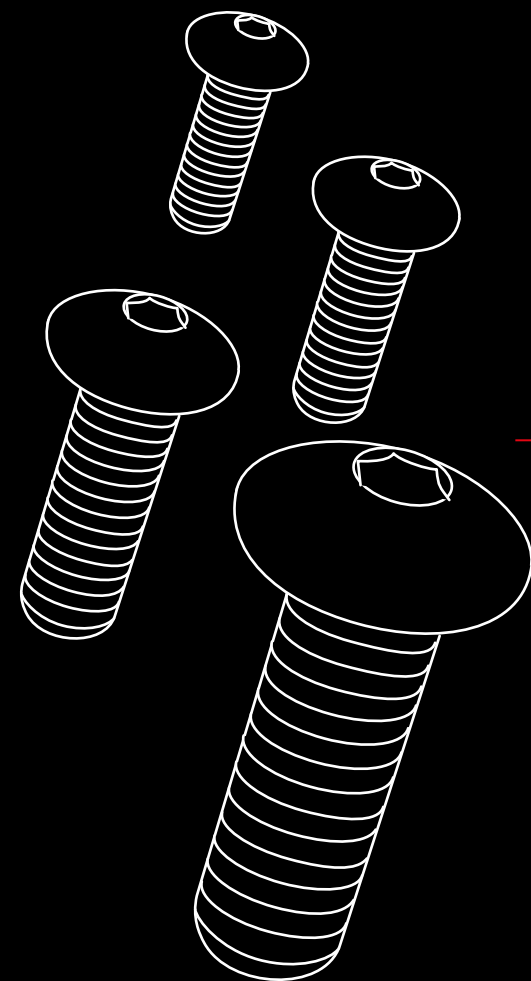
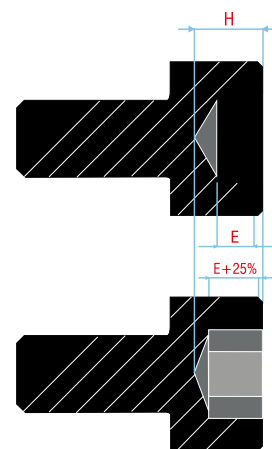

TCCE

MODEL	CODE	COLOUR	EURO w/o tax
M5X8	TCCE	Si Dn Rg Cr Eb	1,20
M5X10	TCCE	Si Dn Rg Cr Eb	1,25
M5X15	TCCE	Si Dn Rg Cr Eb	1,30
M5X20	TCCE	Si Dn Rg Cr Eb	1,40
M5X25	TCCE	Si Dn Rg Cr Eb	1,50
M5X30	TCCE	Si Dn Rg Cr Eb	1,55
M5X35	TCCE	Si Dn Rg Cr Eb	1,60
M5X40	TCCE	Si Dn Rg Cr Eb	1,70
M5X50	TCCE	Si Dn Rg Cr Eb	1,80
M5X70	TCCE	Si Dn Rg Cr Eb	2,00
M6X10	TCCE	Si Dn Rg Cr Eb	1,25
M6X15	TCCE	Si Dn Rg Cr Eb	1,30
M6X20	TCCE	Si Dn Rg Cr Eb	1,40
M6X25	TCCE	Si Dn Rg Cr Eb	1,50
M6X30	TCCE	Si Dn Rg Cr Eb	1,55
M6X35	TCCE	Si Dn Rg Cr Eb	1,60
M6X40	TCCE	Si Dn Rg Cr Eb	1,65
M6X45	TCCE	Si Dn Rg Cr Eb	1,75
M6X50	TCCE	Si Dn Rg Cr Eb	1,80
M6X55	TCCE	Si Dn Rg Cr Eb	1,90
M6X60	TCCE	Si Dn Rg Cr Eb	2,00
M6X65	TCCE	Si Dn Rg Cr Eb	2,10
M6X70	TCCE	Si Dn Rg Cr Eb	2,20
M6X75	TCCE	Si Dn Rg Cr Eb	2,30
M6X80	TCCE	Si Dn Rg Cr Eb	2,45
M6X85	TCCE	Si Dn Rg Cr Eb	2,50
M6X90	TCCE	Si Dn Rg Cr Eb	2,60
M6X95	TCCE	Si Dn Rg Cr Eb	2,80
M6X100	TCCE	Si Dn Rg Cr Eb	2,90
M8X10	TCCE	Si Dn Rg Cr Eb	1,50
M8X15	TCCE	Si Dn Rg Cr Eb	1,60
M8X20	TCCE	Si Dn Rg Cr Eb	1,65
M8X25	TCCE	Si Dn Rg Cr Eb	1,75
M8X30	TCCE	Si Dn Rg Cr Eb	1,80
M8X35	TCCE	Si Dn Rg Cr Eb	1,90
M8X40	TCCE	Si Dn Rg Cr Eb	1,95
M8X45	TCCE	Si Dn Rg Cr Eb	2,00
M8X50	TCCE	Si Dn Rg Cr Eb	2,10
M8X55	TCCE	Si Dn Rg Cr Eb	2,20
M8X60	TCCE	Si Dn Rg Cr Eb	2,30

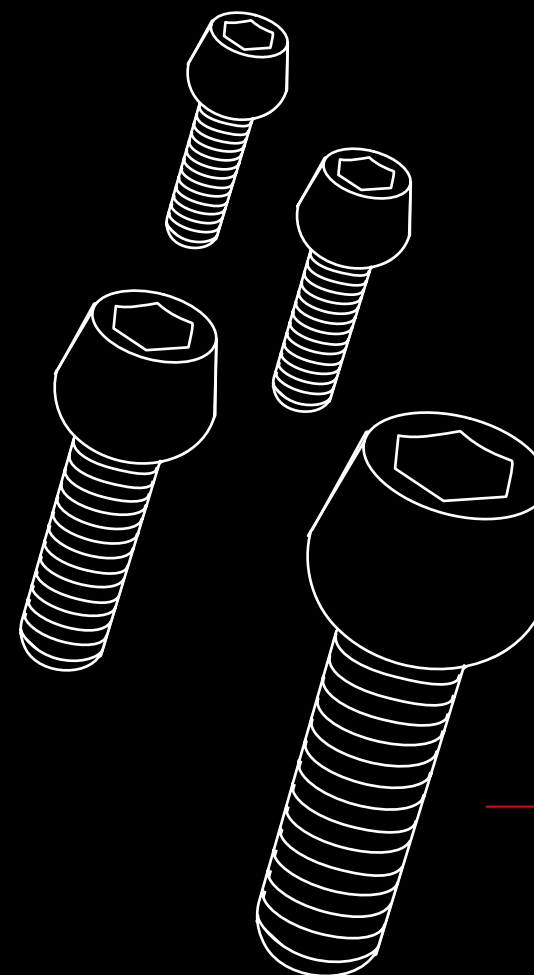

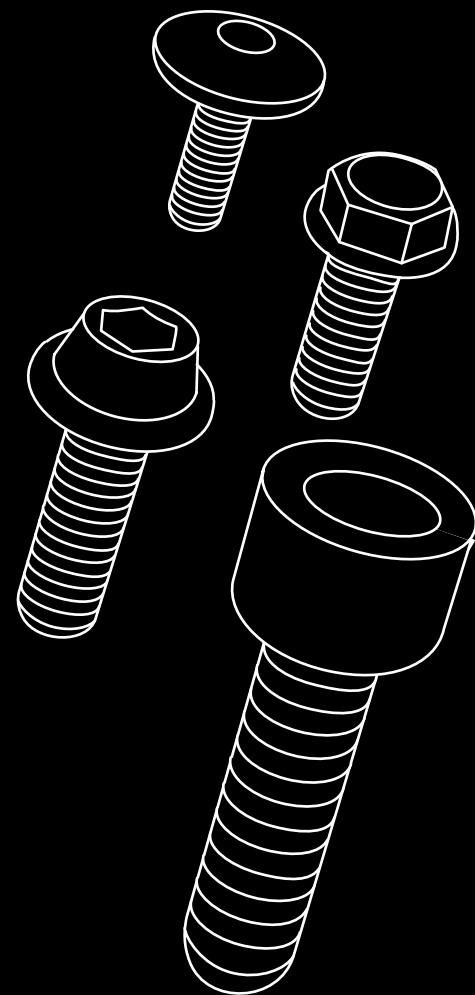

TCEI

MODEL	CODE	COLOUR	EURO w/o tax
M4X8 NEW	TCEI	Si Dn Rg Cr Eb	1,20
M4X10 NEW	TCEI	Si Dn Rg Cr Eb	1,25
M4X15 NEW	TCEI	Si Dn Rg Cr Eb	1,35
M4X20 NEW	TCEI	Si Dn Rg Cr Eb	1,40
M4X25 NEW	TCEI	Si Dn Rg Cr Eb	1,50
M5X8	TCEI	Si Dn Rg Cr Eb	1,20
M5X10	TCEI	Si Dn Rg Cr Eb	1,25
M5X12	TCEI	Si Dn Rg Cr Eb	1,27
M5X15	TCEI	Si Dn Rg Cr Eb	1,30
M5X20	TCEI	Si Dn Rg Cr Eb	1,40
M5X25	TCEI	Si Dn Rg Cr Eb	1,50
M5X30	TCEI	Si Dn Rg Cr Eb	1,55
M5X65	TCEI	Si Dn Rg Cr Eb	2,00
M6X8	TCEI	Si Dn Rg Cr Eb	1,20
M6X10	TCEI	Si Dn Rg Cr Eb	1,25
M6X12	TCEI	Si Dn Rg Cr Eb	1,27
M6X15	TCEI	Si Dn Rg Cr Eb	1,30
M6X20	TCEI	Si Dn Rg Cr Eb	1,40
M6X25	TCEI	Si Dn Rg Cr Eb	1,50
M6X30	TCEI	Si Dn Rg Cr Eb	1,55
M6X35	TCEI	Si Dn Rg Cr Eb	1,60



TCRCE

MODEL	CODE	COLOUR	EURO w/o tax
M6X10	TCRCE	Si Dn Rg Cr Eb	1,40
M6X15	TCRCE	Si Dn Rg Cr Eb	1,45
M6X20	TCRCE	Si Dn Rg Cr Eb	1,50
M6X25	TCRCE	Si Dn Rg Cr Eb	1,60
M6X30	TCRCE	Si Dn Rg Cr Eb	1,70
M6X35	TCRCE	Si Dn Rg Cr Eb	1,75
M6X40	TCRCE	Si Dn Rg Cr Eb	1,80
M8X35	TCRCE	Si Dn Rg Cr Eb	2,60
M8X40	TCRCE	Si Dn Rg Cr Eb	2,70
M8X45	TCRCE	Si Dn Rg Cr Eb	2,80
M8X50	TCRCE	Si Dn Rg Cr Eb	2,90
M8X55	TCRCE	Si Dn Rg Cr Eb	3,10



TER

MODEL	CODE	COLOUR	EURO w/o tax
M5X10	TER	Si Dn Rg Cr Eb	1,65
M5X15	TER	Si Dn Rg Cr Eb	1,75
M5X20	TER	Si Dn Rg Cr Eb	1,80
M5X25	TER	Si Dn Rg Cr Eb	1,85
M5X30	TER	Si Dn Rg Cr Eb	1,90
M5X35	TER	Si Dn Rg Cr Eb	2,00
M6X10	TER	Si Dn Rg Cr Eb	1,85
M6X15	TER	Si Dn Rg Cr Eb	1,90
M6X20	TER	Si Dn Rg Cr Eb	2,00
M6X25	TER	Si Dn Rg Cr Eb	2,05
M6X30	TER	Si Dn Rg Cr Eb	2,10
M6X35	TER	Si Dn Rg Cr Eb	2,15



TER

MODEL	CODE	COLOUR	EURO w/o tax
M6X40	TER	Si Dn Rg Cr Eb	2,25
M6X45	TER	Si Dn Rg Cr Eb	2,40
M6X50	TER	Si Dn Rg Cr Eb	2,45
M6X55	TER	Si Dn Rg Cr Eb	2,60
M6X60	TER	Si Dn Rg Cr Eb	2,70
M6X65	TER	Si Dn Rg Cr Eb	2,80
M6X70	TER	Si Dn Rg Cr Eb	2,90
M6X75	TER	Si Dn Rg Cr Eb	3,00
M6X80	TER	Si Dn Rg Cr Eb	3,10
M6X85	TER	Si Dn Rg Cr Eb	3,20
M6X90	TER	Si Dn Rg Cr Eb	3,30
M6X95	TER	Si Dn Rg Cr Eb	3,40
M6X100	TER	Si Dn Rg Cr Eb	3,60
M8X10	TER	Si Dn Rg Cr Eb	2,05
M8X15	TER	Si Dn Rg Cr Eb	2,20
M8X20	TER	Si Dn Rg Cr Eb	2,30
M8X25	TER	Si Dn Rg Cr Eb	2,40
M8X30	TER	Si Dn Rg Cr Eb	2,50
M8X35	TER	Si Dn Rg Cr Eb	2,60
M8X40	TER	Si Dn Rg Cr Eb	2,70
M8X45	TER	Si Dn Rg Cr Eb	2,80
M8X50	TER	Si Dn Rg Cr Eb	2,90
M8X55	TER	Si Dn Rg Cr Eb	3,10
M8X60	TER	Si Dn Rg Cr Eb	3,20



TTLEI

MODEL	CODE	COLOUR	EURO w/o tax
M5X10	TTLEI	Si Dn Rg Cr Eb	1,65
M5X15	TTLEI	Si Dn Rg Cr Eb	1,75
M5X20	TTLEI	Si Dn Rg Cr Eb	1,80
M5X25	TTLEI	Si Dn Rg Cr Eb	1,90
M5X30	TTLEI	Si Dn Rg Cr Eb	2,00
M5X35	TTLEI	Si Dn Rg Cr Eb	2,05
M6X10	TTLEI	Si Dn Rg Cr Eb	1,90
M6X15	TTLEI	Si Dn Rg Cr Eb	1,95
M6X20	TTLEI	Si Dn Rg Cr Eb	2,05
M6X25	TTLEI	Si Dn Rg Cr Eb	2,15
M8X15	TTLEI	Si Dn Rg Cr Eb	2,20
M8X20	TTLEI	Si Dn Rg Cr Eb	2,30
M8X25	TTLEI	Si Dn Rg Cr Eb	2,40
M8X30	TTLEI	Si Dn Rg Cr Eb	2,50
M8X35	TTLEI	Si Dn Rg Cr Eb	2,60
M8X40	TTLEI	Si Dn Rg Cr Eb	2,70
M8X45	TTLEI	Si Dn Rg Cr Eb	2,80
M8X50	TTLEI	Si Dn Rg Cr Eb	2,90



VITI SPECIALI IN ERGAL / SPECIAL ERGAL BOLTS / DURALUMINIUM SPEZIAL-SCHRAUBEN
TORNILLERÍA ESPECIAL / VIS SPECIAL

CODE	M	LG	DC	LC	DT	COLOUR	EURO w/o tax
VS-001	M5	16,5	8,1	5,9	14	Dn Rg Cr Eb	2,40
VS-002	M5	12,5	8,1	2,8	14	Dn Rg Cr Eb	2,40
VS-003	M6	20	8,55	10	18	Dn Rg Cr Eb	3,00
VS-004	M6	12,5	8,2	2,8	14	Dn Rg Cr Eb	2,40
VS-005	M6	16,5	8,15	4,9	14	Dn Rg Cr Eb	2,40
VS-006	M5	11,6	8	2,6	14	Dn Rg Cr Eb	2,40
VS-007	M5	12	7	2	14	Dn Rg Cr Eb	2,40
VS-008	M5	13	8,55	4	14	Dn Rg Cr Eb	2,40
VS-009	M4	12	/	/	9	Dn Rg Cr Eb	1,70
VS-010	M6	17,4	7,9	8,4	17	Dn Rg Cr Eb	2,40
VS-011	M5	15	7,4	7,5	12	Dn Rg Cr Eb	2,40
VS-012	M5	14	8,5	6	14	Dn Rg Cr Eb	2,40
VS-013	M5	12	7,9	3,5	12,3	Dn Rg Cr Eb	2,40
VS-014	M5	13,6	7,9	5,5	12,3	Dn Rg Cr Eb	2,40
VS-015	M5	8	5	5	19	Dn Rg Cr Eb	2,40
VS-016	M5	16,4	8,5	3,5	18	Dn Rg Cr Eb	2,40
VS-017	M6	12,5	10	4,2	14	Dn Rg Cr Eb	2,40
VS-018	M5	13	8,5	5	19	Dn Rg Cr Eb	2,40
VS-019	M5	12	8,5	3,5	19	Dn Rg Cr Eb	2,40
VS-020	M6	20,4	9,9	10	16,8	Dn Rg Cr Eb	2,40
VS-021	M4	21	/	/	10	Dn Rg Cr Eb	1,40
VS-022	M4	6,5	/	/	10	Dn Rg Cr Eb	1,25
VS-023	M6	6,5	/	/	10	Dn Rg Cr Eb	1,25
VS-024	M5	15	/	/	8,5	Dn Rg Cr Eb	1,40
VS-025	M6	11,5	8,2	3,75	14	Dn Rg Cr Eb	2,40
VS-026	M6	15	7,9	6	14	Dn Rg Cr Eb	2,40
VS-027	M6	15	8,9	4	14	Dn Rg Cr Eb	2,40
VS-028	M6	23	9	4	14	Dn Rg Cr Eb	2,40
VS-029	M6	15	9,9	3,5	17	Dn Rg Cr Eb	2,40
VS-030	M6	15	9	2	14	Dn Rg Cr Eb	2,40
VS-031	M6	14	7,9	5,5	14	Dn Rg Cr Eb	2,40
VS-032	M6	21	8,25	13	17	Dn Rg Cr Eb	2,40
VS-033	M6	25,5	8	10,5	24	Dn Rg Cr Eb	2,40
VS-034	M6	19,7	9,9	8,7	17	Dn Rg Cr Eb	2,40
VS-035	M6	11,9	7,9	3,9	16	Dn Rg Cr Eb	2,40
VS-036	M6	18,3	7,8	7,8	15,6	Dn Rg Cr Eb	2,40
VS-037	M6	10,5	6,9	4,4	14	Dn Rg Cr Eb	2,40
VS-038	M6	15	7,9	6	17	Dn Rg Cr Eb	2,40
VS-039	M6	11	9,9	3,5	17	Dn Rg Cr Eb	2,40
VS-040	M6	15	9,5	6	17	Dn Rg Cr Eb	2,40
VS-041	M6	14,5	11,9	3,5	17	Dn Rg Cr Eb	2,40
VS-042	M6	16	9	3,8	14	Dn Rg Cr Eb	2,40
VS-043	M6	19,5	7,5	3,5	14	Dn Rg Cr Eb	2,40
VS-044	M6	20	10	3	17	Dn Rg Cr Eb	2,40
VS-046	M6	18,3	9,88	7,5	20,16	Dn Rg Cr Eb	2,40
VS-047	M6	12,5	8,7	5,9	14	Dn Rg Cr Eb	2,40
VS-049	M6	15	10	3	15	Dn Rg Cr Eb	2,40
VS-050	M5	18	8	3,5	15	Dn Rg Cr Eb	2,40
VS-051	M5	10,3	8,9	2,6	/	Dn Rg Cr Eb	2,40
VS-052	M6	15	8,4	3	14	Dn Rg Cr Eb	2,40

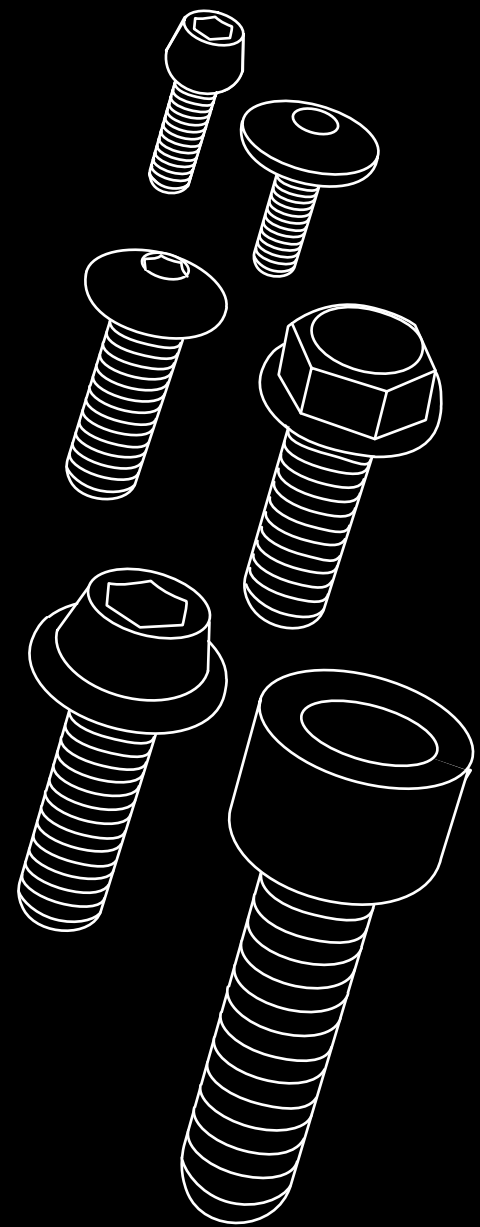

M Diametro filetto
Thread diameter
Durchmesser Gewinde
Diámetro rosca
Diamètre fileta

LG Lunghezza gambo
Shank length
Lange Schaft
Longitud rosca
Longueur guidagec

DC Diametro cilindro
Cylinder diameter
Durchmesser Schaft
Diámetro cilindro
Diamètre cylindre

LC Lunghezza cilindro
Cylinder length
Länge Zylinder
Longitud cilindro
Longueur cylindre

DT Diametro testa
Head diameter
Durchmesser Kopf
Diámetro cabeza
Diamètre de tete

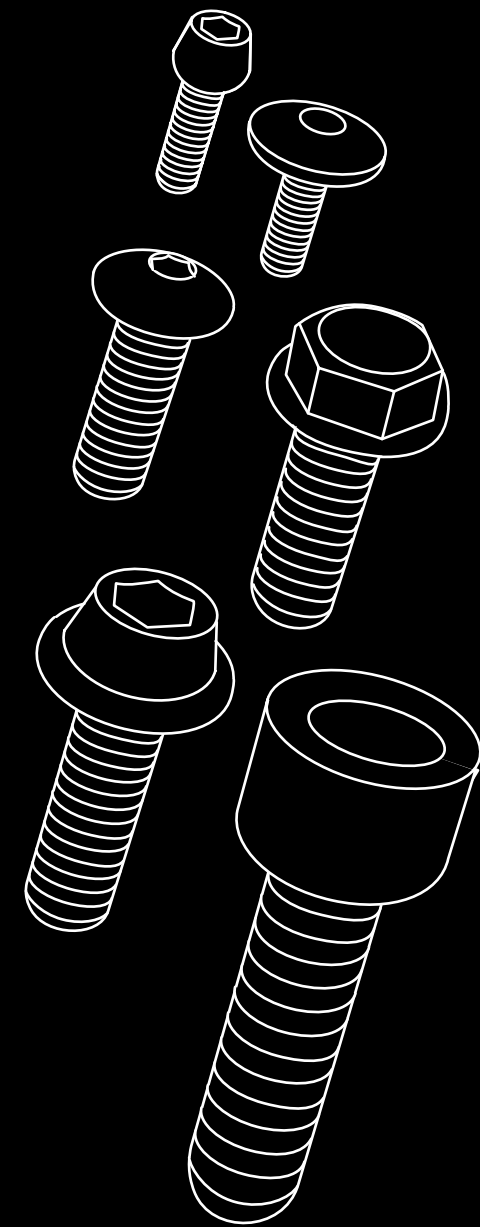
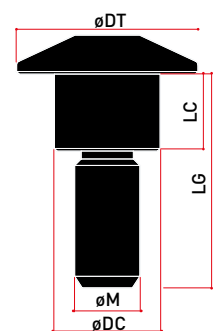

CODE	M	LG	DC	LC	DT	COLOUR	EURO w/o tax
VS-053	M6	15	9,85	5	22	Dn Rg Cr Eb	2,40
VS-054	M6	19	7,9	8	14	Dn Rg Cr Eb	2,40
VS-056	M6	14	7,9	3,8	14	Dn Rg Cr Eb	2,40
VS-057	M5	15,6	7,9	2,6	14	Dn Rg Cr Eb	2,40
VS-058	M6	15	7,9	3	14	Dn Rg Cr Eb	2,40
VS-059	M5	15	7,4	2,3	13	Dn Rg Cr Eb	2,40
VS-060	M5	13	8,9	3	14	Dn Rg Cr Eb	2,40
VS-061	M6	15	8,9	5	14	Dn Rg Cr Eb	2,40
VS-062	M5	15	7	2,5	11,5	Dn Rg Cr Eb	2,40
VS-063	M5	20,5	7	13,5	12	Dn Rg Cr Eb	2,40
VS-064	M5	20,5	6,9	2,5	12	Dn Rg Cr Eb	2,40
VS-065	M6	11	8,2	4	14	Dn Rg Cr Eb	2,40
VS-066	M6	15	9,8	5,5	22	Dn Rg Cr Eb	2,40
VS-067	M5	12,5	8,1	4	12	Dn Rg Cr Eb	2,40
VS-068	M5	16,5	8,1	3,7	12	Dn Rg Cr Eb	2,40
VS-069	M6	25,5	8	13,5	17	Dn Rg Cr Eb	2,40
VS-070	M5	11,9	6,87	2,4	11,55	Dn Rg Cr Eb	2,40
VS-071	M6	21	10	8	17	Dn Rg Cr Eb	2,40
VS-072	M5	17	9	3,2	14	Dn Rg Cr Eb	2,40
VS-073	M5	16	8,2	7,9	14	Dn Rg Cr Eb	2,40
VS-074	M6	13,6	8,3	3,6	16,2	Dn Rg Cr Eb	2,40
VS-075	M6	16,5	8,2	5	12	Dn Rg Cr Eb	2,40
VS-076	M6	17	9	8,8	15	Dn Rg Cr Eb	2,40
VS-077	M6	9	8,9	5,8	17,9	Dn Rg Cr Eb	2,40
VS-078	M6	20	8,7	9,2	14	Dn Rg Cr Eb	2,40
VS-079	M8	30	10	5	14,7	Dn Rg Cr Eb	3,50
VS-080	M8	30	10	5	18	Dn Rg Cr Eb	3,50
VS-081	M8	20	9,9	5,5	16,7	Dn Rg Cr Eb	3,50
VS-082	M8	24,5	9,9	5,5	18	Dn Rg Cr Eb	3,50
VS-083	M6	6	8,3	5,5	18	Dn Rg Cr Eb	2,40
VS-084	M6	10	8	9	16	Dn Rg Cr Eb	2,40
VS-085	M6	10	10	5,6	18	Dn Rg Cr Eb	2,40
VS-086	M5	10	8,15	5,5	14	Dn Rg Cr Eb	2,40
VS-087	M5	10	8,15	3	14	Dn Rg Cr Eb	2,40
VS-088	M6	13	0,86	3	18	Dn Rg Cr Eb	2,40
VS-089	M6	19	8,7	9	14	Dn Rg Cr Eb	2,40
VS-090	M5	9	10	2,5	14	Dn Rg Cr Eb	2,40
VS-092	M8	58	12,45	19,10	22	Dn Rg Cr Eb	5,00
VS-093	M8	24,5	9,9	5,5	14,7	Dn Rg Cr Eb	3,50
VS-094	M6	24,62	10,95	12,62	19,9	Dn Rg Cr Eb	2,40
VS-095	M6	7	8,9	5,5	14,6	Dn Rg Cr Eb	2,40
VS-096	M6	20	9,8	8,6	17	Dn Rg Cr Eb	2,40
VS-097	M5	14,5	8	4	12	Dn Rg Cr Eb	2,40
VS-098	M5	13	7	3,72	12	Dn Rg Cr Eb	2,40
VS-099	M6	25	10	12,75	20	Dn Rg Cr Eb	2,40
VS-100	M6	16	9,3	5,5	16	Dn Rg Cr Eb	2,40
VS-101	M6	14	8,5	4	13,7	Dn Rg Cr Eb	2,40
VS-102	M5	14	8	2,5	12,6	Dn Rg Cr Eb	2,40
VS-103	M5	12,6	8,15	3,5	14,9	Dn Rg Cr Eb	2,40
VS-104	M5	18,5	7,44	9	13	Dn Rg Cr Eb	2,40
VS-105	M5	18	8,5	4	14	Dn Rg Cr Eb	2,40
VS-106	M5	12,4	8	3,5	15	Dn Rg Cr Eb	2,40
VS-106 DADO	M6	15	8,9	15	14	Dn Rg Cr Eb	2,40

M Diametro filetto
Thread diameter
Durchmesser Gewinde
Diámetro rosca
Diamètre fileta

LG Lunghezza gambo
Shank length
Lange Schaft
Longitud rosca
Longueur guidagec

DC Diametro cilindro
Cylinder diameter
Durchmesser Schaft
Diámetro cilindro
Diamètre cylindre

LC Lunghezza cilindro
Cylinder length
Länge Zylinder
Longitud cilindro
Longueur cylindre

DT Diametro testa
Head diameter
Durchmesser Kopf
Diámetro cabeza
Diamètre de tete

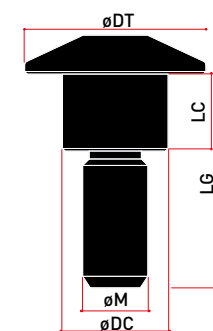

KIT VITI CUPOLINO / SCREEN BOLTS KIT / SCHRAUBENSÄTZE FÜR VERKLEIDUNGSSCHEIBEN
KIT TORNILLERÍA CÚPULA / KIT VISSERIE BULLE

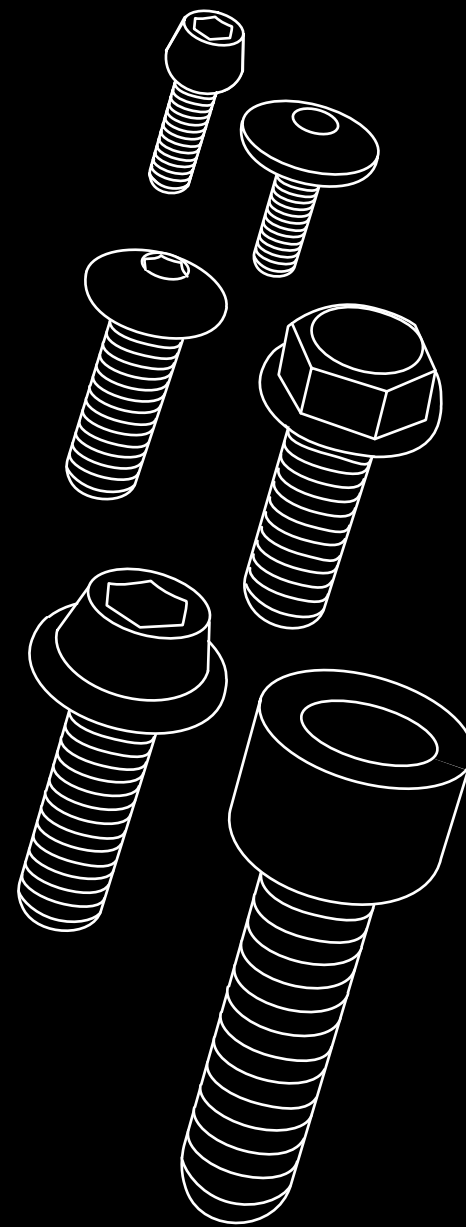

BRAND	MODEL	YEAR	CODE	COLOUR	EURO w/o tax	
APRILIA	RS 125	'06 >	KVC-032	St Dn Rg Cr Eb	17,60	
	RS 250	'99 >	KVC-030	St Dn Rg Cr Eb	7,40	
	RS V4	/	KVC-020	St Dn Rg Cr Eb	6,80	
	RSV 1000/R FACTORY	'01-'03	KVC-002	St Dn Rg Cr Eb	14,40	
	RSV 1000/R FACTORY	'04-'05	KVC-003	St Dn Rg Cr Eb	13,20	
	SHIVER 750	'07 >	KVC-029	St Dn Rg Cr Eb	7,20	
	TUONO 1000/R	'03-'05	KVC-001	St Dn Rg Cr Eb	15,00	
	R1200 R	'15	KVC-029	St Dn Rg Cr Eb	7,20	
	S1000RR	'10-'14	KVC-034	St Dn Rg Cr Eb	14,00	
	S1000RR	'15	KVC-041	St Dn Rg Cr Eb	10,50	
BMW	C600 Sport	/	KVC-038	St Dn Rg Cr Eb	10,70	
	748 / 749	/	KVC-004	St Dn Rg Cr Eb	15,30	
	848	/	KVC-007	St Dn Rg Cr Eb	13,60	
	916 / 996 / 999	/	KVC-004	St Dn Rg Cr Eb	15,30	
	998	/	KVC-018	St Dn Rg Cr Eb	19,40	
	1098 / 1198	/	KVC-007	St Dn Rg Cr Eb	13,60	
	MONSTER DS 1000	'03 -	KVC-006	St Dn Rg Cr Eb	22,40	
	MONSTER S4	'01-'02	KVC-005	St Dn Rg Cr Eb	7,30	
	PANIGALE 899 / 1199	'12-'14	KVC-020	St Dn Rg Cr Eb	6,80	
	CBR 600 F	'11 >	KVC-012	St Dn Rg Cr Eb	9,60	
DUCATI	CBR 600 F / S	'01-'06	KVC-008	St Dn Rg Cr Eb	10,50	
	CBR 600 RR	'03-'06	KVC-008	St Dn Rg Cr Eb	10,50	
	CBR 600 RR	'07-'12	KVC-015	St Dn Rg Cr Eb	14,10	
	CBR 600 RR	'13 >	KVC-029	St Dn Rg Cr Eb	7,20	
	CBR 900 RR	'97-'99	KVC-008	St Dn Rg Cr Eb	10,50	
	CBR 929 RR	'00-'01	KVC-008	St Dn Rg Cr Eb	10,50	
	CBR 954 RR	'02-'03	KVC-010	St Dn Rg Cr Eb	22,75	
	CBR 1000 RR	'04-'07	KVC-008	St Dn Rg Cr Eb	10,50	
	CBR 1000 RR	'08-'14	KVC-016	St Dn Rg Cr Eb	7,00	
	HORNET 600	'11-'13	KVC-011	St Dn Rg Cr Eb	3,50	
HONDA	VTR SP1 / SP2	'00-'03	KVC-008	St Dn Rg Cr Eb	10,50	
	F3	'12-'15	KVC-007	St Dn Rg Cr Eb	13,60	
	F4 750	/	KVC-013	St Dn Rg Cr Eb	17,50	
	F4 1000	/	KVC-013	St Dn Rg Cr Eb	17,50	
	RIVALE 800	/	KVC-014	St Dn Rg Cr Eb	11,80	
	VERSYS 1000	'12 >	KVC-029	St Dn Rg Cr Eb	7,20	
	Z 250 / Z 300	'15	KVC-029	St Dn Rg Cr Eb	7,20	
	Z 800	'13-'16	KVC-016	St Dn Rg Cr Eb	7,00	
	Z 1000	'03-'06	KVC-016	St Dn Rg Cr Eb	7,00	
	ZX 6R	'00-'02	KVC-008	St Dn Rg Cr Eb	10,50	
MV AGUSTA	ZX 6R/RR	'03-'04	KVC-015	St Dn Rg Cr Eb	14,10	
	ZX 6R	'05-'08	KVC-008	St Dn Rg Cr Eb	10,50	
	ZX 6R	'09-'15	KVC-023	St Dn Rg Cr Eb	16,50	
	ZX 9R	'00-'03	KVC-008	St Dn Rg Cr Eb	10,50	
	ZX 10R	'04-'10	KVC-008	St Dn Rg Cr Eb	10,50	
	ZX 10R	'11-'15	KVC-009	St Dn Rg Cr Eb	8,75	
	ZX 12R	'00	KVC-008	St Dn Rg Cr Eb	10,50	
	KAWASAKI					

BRAND
KTM
SUZUKI
TRIUMPH
YAMAHA

MODEL	YEAR	CODE	COLOUR	EURO w/o tax
990 SUPERMOTO T	/	KVC-033	St Dn Rg Cr Eb	14,40
DUKE 125 / 390	'11-'14	KVC-037	St Dn Rg Cr Eb	8,20
SUPER DUKE 990	'07 >	KVC-016	St Dn Rg Cr Eb	7,00
GSX-R 600 / 750	'04-'05	KVC-016	St Dn Rg Cr Eb	7,00
GSX-R 600 / 750	'06-'10	KVC-024	St Dn Rg Cr Eb	10,60
GSX-R 600 / 750	'11-'15	KVC-036	St Dn Rg Cr Eb	10,80
GSX-R 1000	'05-'15	KVC-008	St Dn Rg Cr Eb	10,50
DAYTONA 675/R	'13 >	KVC-016	St Dn Rg Cr Eb	7,00
FAZER 600	'99-'03	KVC-026	St Dn Rg Cr Eb	14,40
FAZER 1000	'99-'05	KVC-026	St Dn Rg Cr Eb	14,40
FZ1 NAKED	'06 >	KVC-031	St Dn Rg Cr Eb	9,60
FZ6 FAZER	'04 >	KVC-025	St Dn Rg Cr Eb	11,30
FZ8	'10 >	KVC-035	St Dn Rg Cr Eb	11,10
MT-07	'14 >	KVC-040	St Dn Rg Cr Eb	13,40
MT-09	'14 >	KVC-039	St Dn Rg Cr Eb	11,90
R1	'98-'16	KVC-008	St Dn Rg Cr Eb	10,50
R3	'15	KVC-016	St Dn Rg Cr Eb	7,00
R6	'99-'00	KVC-027	St Dn Rg Cr Eb	11,80
R6	'03-'15	KVC-016	St Dn Rg Cr Eb	7,00
XJ6	'09 >	KVC-030	St Dn Rg Cr Eb	7,40
YZF-R125	'14 >	KVC-008	St Dn Rg Cr Eb	10,50

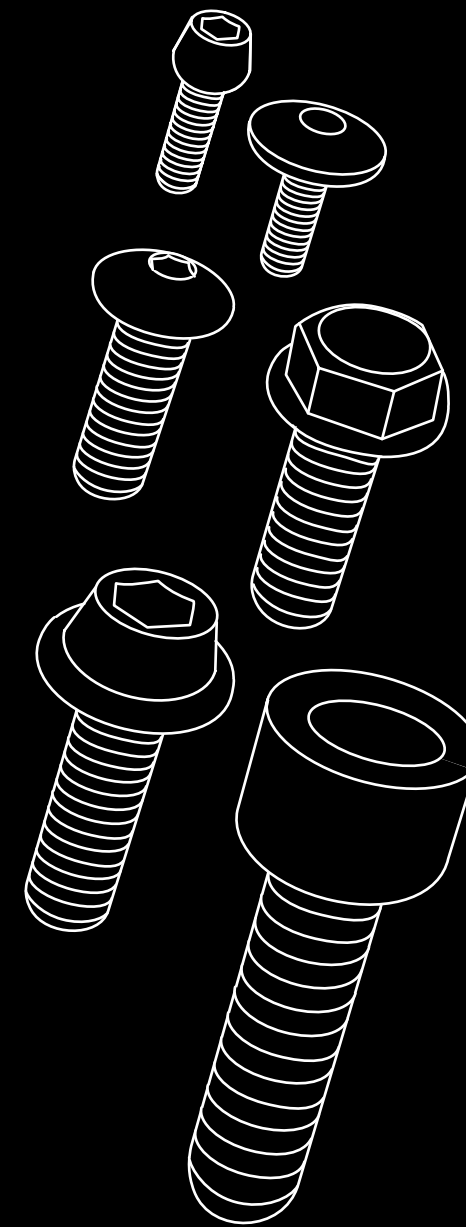

BRAND
APRILIA
BENELLI
BMW

KIT VITI TAPPO SERBATOIO / FUEL CAP BOLTS KIT / SCHRAUBENSÄTZE FÜR TANKDECKEL
KIT TORNILLERÍA DEPOSITO / KIT VISSERIE TRAPPE À ESSENCE

MODEL	YEAR	CODE	COLOUR	EURO w/o tax
RS 125	'97-'05	KVS-003	St Dn Rg Cr Eb	10,10
RS 125	'06 >	KVS-043	St Dn Rg Cr Eb	9,90
RS 250 REPLICIA	'99 >	KVS-005	St Dn Rg Cr Eb	8,30
RSV 1000/R/FACTORY	'98-'14	KVS-004	St Dn Rg Cr Eb	8,55
SHIVER 750	'07 >	KVS-004	St Dn Rg Cr Eb	8,55
TUONO 1000 R	'02-'10	KVS-004	St Dn Rg Cr Eb	8,55
TUONO V4	'04-'10	KVS-004	St Dn Rg Cr Eb	8,55
TNT 1130 / 899	/	KVS-004	St Dn Rg Cr Eb	8,55
TRE 1130 K	/	KVS-004	St Dn Rg Cr Eb	8,55
F 650 ENDURO	'93-'99	KVS-007	St Dn Rg Cr Eb	9,00
K 1200 GT	'06 >	KVS-007	St Dn Rg Cr Eb	9,00
K 1200 R	'05 >	KVS-007	St Dn Rg Cr Eb	9,00
K 1200 RS	'97-'05	KVS-007	St Dn Rg Cr Eb	9,00
R 1100 RT	'95-'00	KVS-007	St Dn Rg Cr Eb	9,00
R 1150 RT	'01-'05	KVS-007	St Dn Rg Cr Eb	9,00
R 1150 GS/ADVENTURE	'99 >	KVS-007	St Dn Rg Cr Eb	9,00
R 1200 CL	'02 >	KVS-007	St Dn Rg Cr Eb	9,00
R 1200 R	'15	KVS-006	St Dn Rg Cr Eb	9,30
R 1100 RS	'98-'03	KVS-007	St Dn Rg Cr Eb	9,00

BRAND

DUCATI

HONDA

MV AGUSTA

KAWASAKI

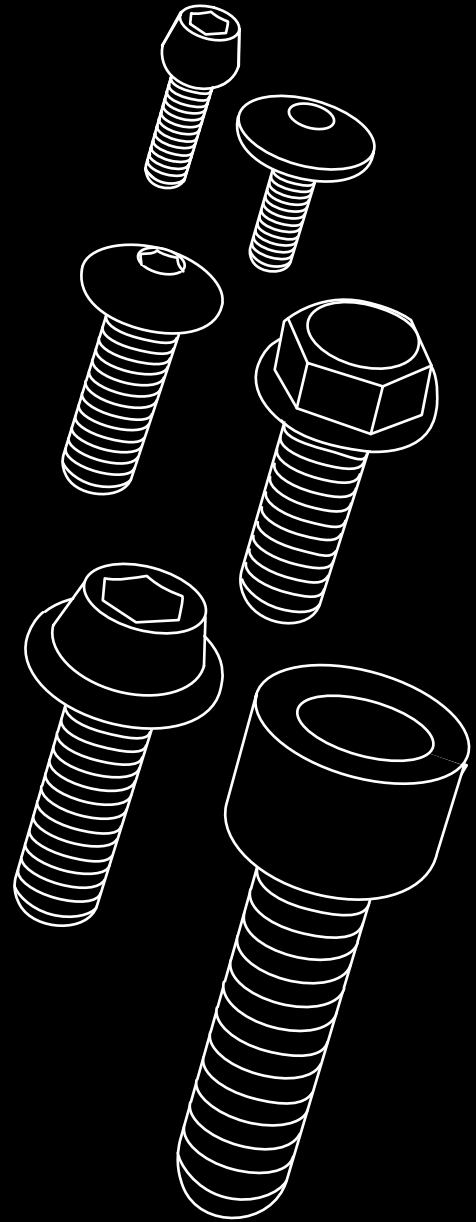

MODEL	YEAR	CODE	COLOUR	EURO w/o tax
748 749	/	KVS-012	Dn Rg Cr Eb	7,00
848	/	KVS-012	Dn Rg Cr Eb	7,00
916 /996 / 999	/	KVS-012	Dn Rg Cr Eb	7,00
1098 /1198	/	KVS-012	Dn Rg Cr Eb	7,00
MONSTER 696	'08 >	KVS-040	Dn Rg Cr Eb	15,40
MONSTER 1100/1100 EVO	'08 >	KVS-040	Dn Rg Cr Eb	15,40
MONSTER 1200	/	KVS-012	Dn Rg Cr Eb	7,00
MONSTER DS 1000	'03 >	KVS-012	Dn Rg Cr Eb	7,00
ST2/ST4	/	KVS-013	Dn Rg Cr Eb	10,70
CB 650F	'14 >	KVS-048	Dn Rg Cr Eb	6,90
CB 1000 R	'08-'15	KVS-015	Dn Rg Cr Eb	9,20
CB 1300	/	KVS-015	Dn Rg Cr Eb	9,20
CBR 600 F	'11-'13	KVS-015	Dn Rg Cr Eb	9,20
CBR 600 RR	>'00	KVS-014	Dn Rg Cr Eb	9,20
CBR 600 RR	'03-'15	KVS-015	Dn Rg Cr Eb	9,20
CBR 900 RR	'96-'99	KVS-014	Dn Rg Cr Eb	9,20
CBR 929 RR	'00-'01	KVS-014	Dn Rg Cr Eb	9,20
CBR 954 RR	'02-'03	KVS-015	Dn Rg Cr Eb	9,20
CBR 1000 RR	'04-'15	KVS-015	Dn Rg Cr Eb	9,20
CBR 1100 XX	/	KVS-014	Dn Rg Cr Eb	9,20
HORNET 600	'03-'13	KVS-015	Dn Rg Cr Eb	9,20
HORNET 900	'03-'07	KVS-015	Dn Rg Cr Eb	9,20
VFR 750	'90-'97	KVS-014	Dn Rg Cr Eb	9,20
VFR 800	'98-'00	KVS-014	Dn Rg Cr Eb	9,20
VFR 800	'01 >	KVS-015	Dn Rg Cr Eb	9,20
VTR 1000 F	/	KVS-014	Dn Rg Cr Eb	9,20
VTR SP1	'00-'01	KVS-014	Dn Rg Cr Eb	9,20
VTR SP2	>'02	KVS-015	Dn Rg Cr Eb	9,20
BRUTALE	5 Viti/Bolts/Schrauben Tornillo/Vis	KVS-012	Dn Rg Cr Eb	7,00
BRUTALE 675	'13-'15	KVS-029	Dn Rg Cr Eb	8,40
BRUTALE 800	/	KVS-029	Dn Rg Cr Eb	8,40
DRAGSTER 800	'14 >	KVS-029	Dn Rg Cr Eb	8,40
F3	/	KVS-029	Dn Rg Cr Eb	8,40
F4 1000/750	5 Viti/Bolts/Schrauben Tornillo/Vis	KVS-012	Dn Rg Cr Eb	7,00
RIVALE 800	/	KVS-029	Dn Rg Cr Eb	8,40
ER6-N/F	'06-'16	KVS-017	Dn Rg Cr Eb	6,40
VERSYS	'07-'14	KVS-017	Dn Rg Cr Eb	6,40
Z 250 /Z 300	'15	KVS-027	Dn Rg Cr Eb	7,80
Z 750	'04 >	KVS-017	Dn Rg Cr Eb	6,40
Z 800	'13-'16	KVS-017	Dn Rg Cr Eb	6,40
Z 1000 / Z 1000 SX	'03-'13	KVS-017	Dn Rg Cr Eb	6,40
Z 1000 / Z 1000 SX	'14-'16	KVS-012	Dn Rg Cr Eb	7,00
ZX 6R / RR	'03-'04	KVS-017	Dn Rg Cr Eb	6,40
ZX 6R / RR	'05-'06	KVS-041	Dn Rg Cr Eb	6,50
ZX 6R / RR	'07-'15	KVS-017	Dn Rg Cr Eb	6,40
ZX 7R	/	KVS-019	Dn Rg Cr Eb	8,89
ZX 9R	'98-'99	KVS-019	Dn Rg Cr Eb	8,89
ZX 9R	'00-'04	KVS-041	Dn Rg Cr Eb	6,50
ZX 10R	'04-'15	KVS-017	Dn Rg Cr Eb	6,40

BRAND

KAWASAKI

SUZUKI

KTM

TRIUMPH

YAMAHA

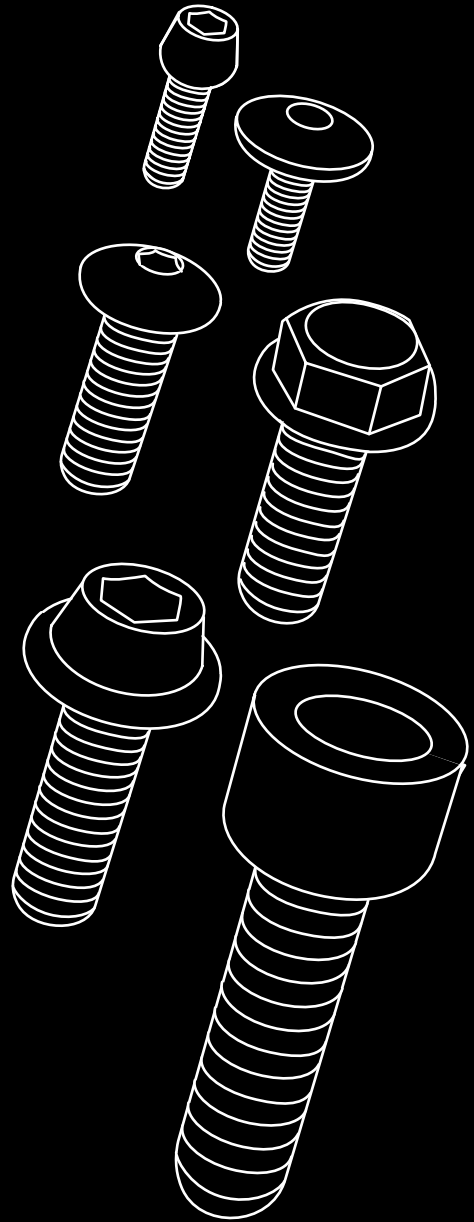

MODEL	YEAR	CODE	COLOUR	EURO w/o tax
ZX 12R	/	KVS-018	Dn Rg Cr Eb	5,10
ZX 250 NINJA	'08-'14	KVS-027	Dn Rg Cr Eb	7,80
FREEWIND 650	/	KVS-023	Dn Rg Cr Eb	9,67
GSF 1200 BANDIT	/	KVS-028	Dn Rg Cr Eb	10,60
GSR 600	'06-'11	KVS-026	Dn Rg Cr Eb	6,67
GSR 750	'11-'15	KVS-026	Dn Rg Cr Eb	6,67
GSX-R 600 / 750	'97-'03	KVS-022	Dn Rg Cr Eb	9,37
GSX-R 600 / 750	'04-'15	KVS-026	Dn Rg Cr Eb	6,67
GSX-R 1000	'01-'02	KVS-022	Dn Rg Cr Eb	9,37
GSX-R 1000	'03-'15	KVS-026	Dn Rg Cr Eb	6,67
GSX-R 1300 HAYABUSA	'99-'07	KVS-022	Dn Rg Cr Eb	9,37
GSX-R 1300 HAYABUSA	'08-'15	KVS-026	Dn Rg Cr Eb	6,67
GSX-S 1000	'15	KVS-026	Dn Rg Cr Eb	6,67
SV 650/S	'99-'02	KVS-028	Dn Rg Cr Eb	10,60
SV 650/S	'03-'14	KVS-026	Dn Rg Cr Eb	6,67
SV 1000/S	'03-'14	KVS-026	Dn Rg Cr Eb	6,67
690 DUKE	'12 >	KVS-029	Dn Rg Cr Eb	8,40
DUKE 125	'11 >	KVS-044	Dn Rg Cr Eb	10,20
RC 125/390	/	KVS-019	Dn Rg Cr Eb	8,89
SUPERDUKE 990	'05-'13	KVS-020	Dn Rg Cr Eb	8,25
DAYTONA 675	'06-'12	KVS-029	Dn Rg Cr Eb	8,40
DAYTONA 675/R	'13 >	KVS-046	Dn Rg Cr Eb	9,55
DAYTONA 955 i	'02-'05	KVS-009	Dn Rg Cr Eb	8,70
SPEED TRIPLE	'97-'15	KVS-029	Dn Rg Cr Eb	8,40
SPRINT	/	KVS-029	Dn Rg Cr Eb	8,40
STREET TRIPLE	'07-'09	KVS-009	Dn Rg Cr Eb	8,70
STREET TRIPLE	'10-'12	KVS-029	Dn Rg Cr Eb	8,40
STREET TRIPLE 675/R	'13 >	KVS-045	Dn Rg Cr Eb	9,70
TT 600	/	KVS-029	Dn Rg Cr Eb	8,40
BT BULLDOG 1100	'02-'06	KVS-010	Dn Rg Cr Eb	8,54
FAZER 600	'97-'03	KVS-024	Dn Rg Cr Eb	9,20
FAZER 1000	'99-'05	KVS-024	Dn Rg Cr Eb	9,20
FZ1 NAKED /FAZER	'06 >	KVS-042	Dn Rg Cr Eb	6,90
FZ6 /FAZER /S2	'04-'09	KVS-036	Dn Rg Cr Eb	6,60
FZ8	/	KVS-042	Dn Rg Cr Eb	6,90
FZR 400 / 600	/	KVS-033	Dn Rg Cr Eb	11,21
MT-03	'06 >	KVS-042	Dn Rg Cr Eb	6,90
MT-07	'14 >	KVS-030	Dn Rg Cr Eb	6,70
MT-09	'14 >	KVS-047	Dn Rg Cr Eb	8,15
MT-09 TRACER	'15	KVS-030	Dn Rg Cr Eb	6,70
R1	'98-'01	KVS-024	Dn Rg Cr Eb	9,20
R1	'02-'03	KVS-036	Dn Rg Cr Eb	6,60
R1	'04-'14	KVS-042	Dn Rg Cr Eb	6,90
R3	'15	KVS-042	Dn Rg Cr Eb	6,90
R6	'01-'04	KVS-012	Dn Rg Cr Eb	7,00
R6	'05-'15	KVS-042	Dn Rg Cr Eb	6,90
TDM 850	'91-'95	KVS-034	Dn Rg Cr Eb	9,28
TDM 850	'96-'01	KVS-035	Dn Rg Cr Eb	9,20
TDM 900	'02-'14	KVS-024	Dn Rg Cr Eb	9,20
XJ6 / XJR 1300	'09 >	KVS-042	Dn Rg Cr Eb	6,90
XVS 1100 DRAGSTAR	'99-'02	KVS-037	Dn Rg Cr Eb	3,81

**KIT VITI MOTORE / ENGINE BOLTS KIT / MOTOR SCHRAUBENSATZ
KIT TORNILLERÍA MOTOR / KIT VIS DE MOTEUR**

MODEL	YEAR	CODE	COLOUR	EURO w/o tax
CAPONORD 1200 <small>NEW</small>	'13	KVM-1012		95,70
DORSODURO 750	'09 >	KVM-1002		87,45
RS 4	'11 >	KVM-1011		58,85
RS 125	'07-'08	KVM-1000		36,15
RS V4 FACTORY	'09-'14	KVM-1010		81,10
RS V1000	'01-'03	KVM-1007		76,15
RS V1000	'04 >	KVM-1001		76,15
SHIVER	/	KVM-1003		87,30
TUONO 1000	'02-'05	KVM-1008		48,25
TUONO V4	'11-'14	KVM-1005		63,85
TUONO V4 1100 RR	'15	KVM-1006		81,40
TNT 899/1130	/	KVM-0601		65,80
C600 Sport	/	KVM-1103		35,75
F800	'13	KVM-1100		61,50
R 1200 GS	'13-'14	KVM-1104		24,00
R NINE T	'14 >	KVM-1105		25,60
S 1000 RR	'09-'14	KVM-1102		85,05
S 1000 RR	'15	KVM-1106		61,40
S 1000 R	'15	KVM-1108		60,25
S 1000 XR	'15	KVM-1107		60,25
600 SS	'94-'96	KVM-0804		93,45
749	/	KVM-0801		73,70
748	/	KVM-0805		101,90
916/996	/	KVM-0805		101,90
999	/	KVM-0801		73,70
1000 S - HYPERMOTARD	/	KVM-0800		65,60
1098	/	KVM-0802		101,55
HYPERSTRADA	'13	KVM-0812		65,90
MONSTER 600	/	KVM-0803		61,55
MONSTER 620	/	KVM-0820		78,20
MONSTER 750	'01 >	KVM-0806		90,80
MONSTER 821	'01 >	KVM-0815-B		78,00
MONSTER 1200	/	KVM-0813		24,05
MULTISTRADA 1200	'10-'14	KVM-0808		52,85
PANIGALE 1199 / 899	'12	KVM-0811		154,70
S4 916	'01 >	KVM-0815		114,50
ST4 916	'99-'00	KVM-0814		138,10
STREET FIGHTER	/	KVM-0807		56,00
CB 1000 R	'08	KVM-0110		75,40
CB 650F	'14 >	KVM-0119		67,55
CBR 125	'11-'14	KVM-0115		47,85
CBR 600 F	'11-'13	KVM-0114		49,70
CBR 600 RR	'05-'06	KVM-0108		68,70
CBR 600 RR	'13 >	KVM-0118		49,95
CBR 1000 RR	'05-'06	KVM-0103		72,75
CBR 1000 RR	'08-'15	KVM-0112		54,40
CRF 250	'09	KVM-0111		40,60
CROSSRUNNER	'11-'12	KVM-0116		58,30

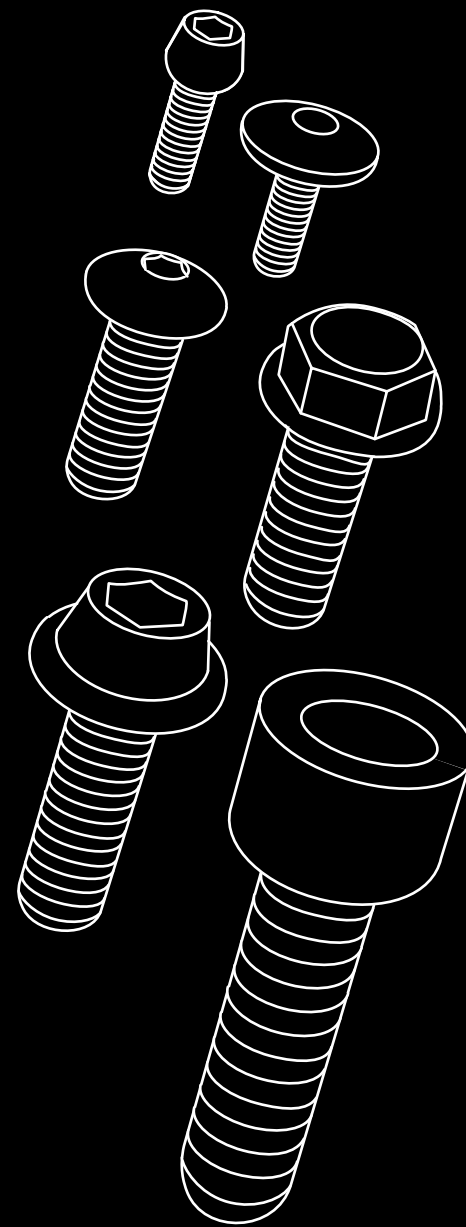

BRAND

APRILIA

BENELLI

BMW

DUCATI

HONDA

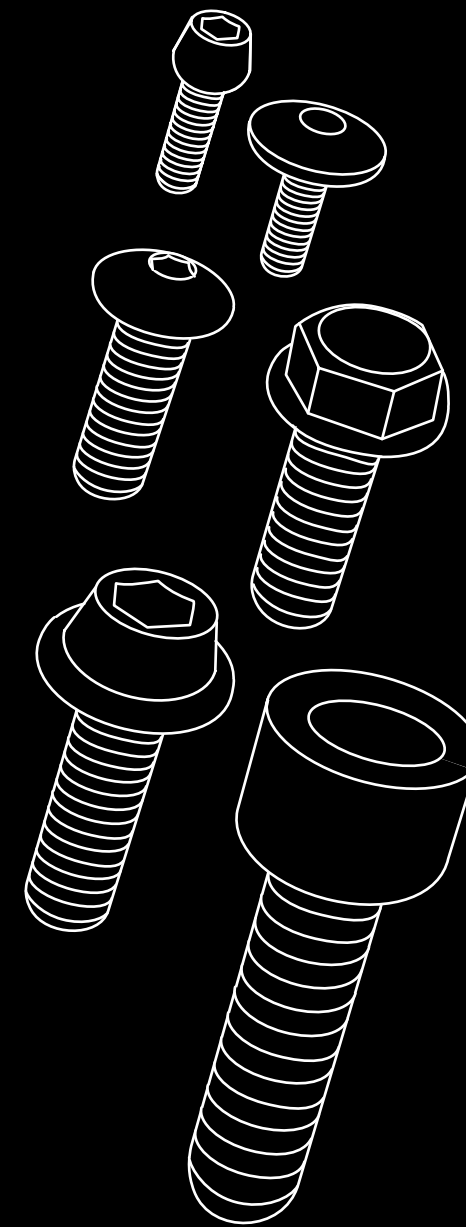

BRAND

HONDA

HUSQVARNA

MV AGUSTA

KAWASAKI

KTM

SUZUKI

TRIUMPH

YAMAHA

MODEL	YEAR	CODE	COLOUR	EURO w/o tax
HORNET 600	'07	KVM-0109		53,30
HORNET 600	'11-'13	KVM-0113		47,90
NUDA 900	'12 >	KVM-1401		107,00
BRUTALE 675	/	KVM-0504		53,35
BRUTALE 750	'10 >	KVM-0501		57,50
BRUTALE 800	/	KVM-0504		53,35
BRUTALE 990	'10 >	KVM-0501		57,50
BRUTALE 910	'10 >	KVM-0501		57,50
BRUTALE 1078	'10 >	KVM-0501		57,50
BRUTALE 1090	'10 >	KVM-0501		57,50
DRAGSTER 800	'14 >	KVM-0507		55,90
F3	'12 >	KVM-0503		57,65
RIVALE 800	/	KVM-0506		40,15
ER6N	'06-'08	KVM-0408		77,00
ER6N	'09-'10	KVM-0409		68,55
ER6N	'11	KVM-0410		60,00
ER6N	'12-'16	KVM-0414		74,95
VERSYS 1000	'12 >	KVM-0415		59,15
Z 250	'15	KVM-0418		57,25
Z 750	'04-'06	KVM-0403		70,20
Z 750	'07-'14	KVM-0406		70,20
Z 800	'13-'16	KVM-0416		67,75
Z 1000	'03-'06	KVM-0402		74,65
Z 1000	'10-'13	KVM-0411		44,25
Z 1000	'14-'16	KVM-0417		58,75
ZX 6R	'03-'04	KVM-0401		75,00
ZX 6R	'05	KVM-0405		73,60
ZX 6R	'09-'15	KVM-0404		89,10
ZX 10R	'04-	KVM-0407		65,60
ZX 10R	'11-'15	KVM-0413		67,85
690 DUKE	'12-'14	KVM-0907		69,15
690 SMC/ENDURO	'08 >	KVM-0902		68,95
DUKE 125	'11 >	KVM-0905		81,60
DUKE 390	'14 >	KVM-0909		70,45
R 1290 SUPERDUKE	'14 >	KVM-0908		112,60
RC 125/390	'14 >	KVM-0910		81,60
SUPERMOTO 990	'09 >	KVM-0904		105,69
GLADIUS	/	KVM-0313		86,20
GSR 750	'11-'15	KVM-0315		69,00
GSX-R 1000	'09-'10	KVM-0312		64,30
GSX-R 600/750	'04-'05	KVM-0301		71,05
GSX-R 600/750	'06	KVM-0306		66,90
GSX-R 600/750	'08-'10	KVM-0309		73,45
GSX-S 1000	'15	KVM-0316		71,70
DAYTONA 675/R	'13 >	KVM-0707		86,70
SPEED TRIPLE	'09-'10	KVM-0704		114,00
SPEED TRIPLE	'11-'15	KVM-0705		110,80
STREET TRIPLE	'07-'12	KVM-0703		76,70
STREET TRIPLE 675/R	'13 >	KVM-0706		79,40
FZ1 NAKED	/	KVM-0209		56,80
FZ8	/	KVM-0206		70,00

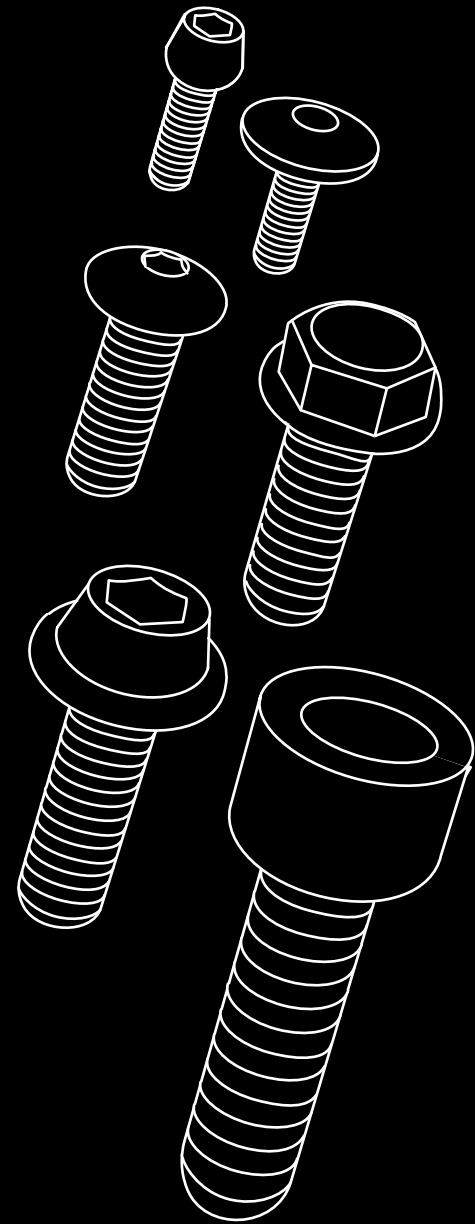

BRAND

MODEL	YEAR	CODE	COLOUR	EURO w/o tax
MT-07	'14 >	KVM-0219	St Dn Rg Cr Eb	45,87
MT-09/TRACER	'14 >	KVM-0218	St Dn Rg Cr Eb	73,70
R1	'02-'03	KVM-0204	St Dn Rg Cr Eb	45,55
R1	'09-'14	KVM-0214	St Dn Rg Cr Eb	64,85
R1	'16	KVM-0213	St Dn Rg Cr Eb	55,10
R3	'15	KVM-0220	St Dn Rg Cr Eb	51,15
R6	'03-'05	KVM-0208	St Dn Rg Cr Eb	70,30
TMAX	'01-'04	KVM-0210	St Dn Rg Cr Eb	42,25
TMAX	'08-'11	KVM-0216	St Dn Rg Cr Eb	62,70
TMAX 530	'12 >	KVM-0217	St Dn Rg Cr Eb	34,45
XJ6	'09 >	KVM-0212	St Dn Rg Cr Eb	56,10
YZF-R 125	'08-'13	KVM-0205	St Dn Rg Cr Eb	77,30

YAMAHA

BRAND

MODEL	YEAR	CODE	COLOUR	EURO w/o tax
CAPONORD 1200 <small>NEW</small>	'13	KVF-1012	St Dn Rg Cr Eb	110,40
DORSODURO 750	'09 >	KVF-1002	St Dn Rg Cr Eb	41,10
RS125	'00-'05	KVF-1004	St Dn Rg Cr Eb	58,60
RS125	'06-'08	KVF-1000	St Dn Rg Cr Eb	76,80
RS 250	'99	KVF-1009	St Dn Rg Cr Eb	91,85
RS4	'11-'14	KVF-1011	St Dn Rg Cr Eb	72,15
RSV4 FACTORY	'09 >	KVF-1010	St Dn Rg Cr Eb	21,45
RSV 1000	'04 >	KVF-1001	St Dn Rg Cr Eb	73,55
SHIVER	/	KVF-1003	St Dn Rg Cr Eb	69,15
TUONO 1000	'02-'05	KVF-1008	St Dn Rg Cr Eb	110,55
TUONO V4	'11-'14	KVF-1005	St Dn Rg Cr Eb	47,10
TUONO V4 1100 RR	'15	KVF-1006	St Dn Rg Cr Eb	44,75
TNT 899/1130	'02-'05	KVF-0601	St Dn Rg Cr Eb	77,70
C 600 Sport	/	KVF-1103	St Dn Rg Cr Eb	56,65
F 800	'13 >	KVF-1100	St Dn Rg Cr Eb	110,25
R 1200 GS	'13	KVF-1104	St Dn Rg Cr Eb	151,50
R NINE T	'14	KVF-1105	St Dn Rg Cr Eb	65,80
S 1000 XR	'15	KVF-1107	St Dn Rg Cr Eb	83,15
R 1200 R	'15	KVF-1107	St Dn Rg Cr Eb	147,15
S 1000 R	'15	KVF-1108	St Dn Rg Cr Eb	75,40
S 1000 RR	'09-'14	KVF-1102	St Dn Rg Cr Eb	142,45
S 1000 RR	'15	KVF-1106	St Dn Rg Cr Eb	120,45
HYPERSTRADA	'13 >	KVF-0812	St Dn Rg Cr Eb	160,05
MONSTER 821	/	KVF-0815	St Dn Rg Cr Eb	78,15
MONSTER 1200	'10-'14	KVF-0813	St Dn Rg Cr Eb	127,00
MULTISTRADA 1200	/	KVF-0808	St Dn Rg Cr Eb	123,15
PANIGALE 899 / 1199	'12	KVF-0811	St Dn Rg Cr Eb	112,35
STREET FIGHTER	/	KVF-0807	St Dn Rg Cr Eb	58,20
CB 650 F	'14	KVF-0119	St Dn Rg Cr Eb	82,25
CRF 250	'09	KVF-0111	St Dn Rg Cr Eb	123,85

APRILIA

BENELLI

BMW

DUCATI

HONDA

KIT VITI CARENA / FAIRING BOLTS KIT / VERKLEIDUNG SCHRAUBENSATZ
KIT TORNILLERÍA CARENADO / KIT VISSERIE CARENAGE

BRAND

MODEL	YEAR	CODE	COLOUR	EURO w/o tax
CBR 125	'11-'14	KVF-0115	St Dn Rg Cr Eb	55,20
CBR 600 F	'11-'13	KVF-0114	St Dn Rg Cr Eb	42,90
CBR 600 RR	'05-'06	KVF-0108	St Dn Rg Cr Eb	94,90
CBR 600 RR	'13 >	KVF-0118	St Dn Rg Cr Eb	118,65
CBR 1000 RR	'05-'06	KVF-0103	St Dn Rg Cr Eb	76,90
CBR 1000 RR	'08-'15	KVF-0112	St Dn Rg Cr Eb	56,10
CROSSRUNNER	'11 >	KVF-0116	St Dn Rg Cr Eb	53,15
HORNET 600	'07	KVF-0109	St Dn Rg Cr Eb	37,40
HORNET 600	'11-'13	KVF-0113	St Dn Rg Cr Eb	39,90
NUDA 900	'12 >	KVF-1401	St Dn Rg Cr Eb	62,65
BRUTALE 675/800	/	KVF-0504	St Dn Rg Cr Eb	20,40
DRAGSTER 800	'14 >	KVF-0507	St Dn Rg Cr Eb	121,45
F3	'12 >	KVF-0503	St Dn Rg Cr Eb	87,65
RIVALE 800	/	KVF-0506	St Dn Rg Cr Eb	119,80
ER6N	'06-'08	KVF-0408	St Dn Rg Cr Eb	65,10
ER6N	'09-'10	KVF-0409	St Dn Rg Cr Eb	56,80
ER6N	'11	KVF-0410	St Dn Rg Cr Eb	45,30
ER6N	'12-'16	KVF-0414	St Dn Rg Cr Eb	65,05
VERSYS 1000	'12 >	KVF-0415	St Dn Rg Cr Eb	63,95
Z 250	'15-'16	KVF-0418	St Dn Rg Cr Eb	70,55
Z 300	'15-'16	KVF-0418	St Dn Rg Cr Eb	70,55
Z 750	'04-'06	KVF-0403	St Dn Rg Cr Eb	36,75
Z 750	'07-'14	KVF-0406	St Dn Rg Cr Eb	36,20
Z 800	'13-'16	KVF-0416	St Dn Rg Cr Eb	91,60
Z 1000	'03-'06	KVF-0402	St Dn Rg Cr Eb	44,45
Z 1000	'10-'13	KVF-0411	St Dn Rg Cr Eb	93,50
Z 1000	'14-'16	KVF-0417	St Dn Rg Cr Eb	98,45
ZX 6R	'03-'04	KVF-0401	St Dn Rg Cr Eb	68,75
ZX 6R	'05	KVF-0405	St Dn Rg Cr Eb	102,00
ZX 6R	'09-'15	KVF-0404	St Dn Rg Cr Eb	117,20
ZX 10R	'04	KVF-0407	St Dn Rg Cr Eb	99,10
ZX 10R	'11-'15	KVF-0413	St Dn Rg Cr Eb	71,90
690 DUKE	'12 >	KVF-0907	St Dn Rg Cr Eb	82,80
690 SMC/ENDURO	'08 >	KVF-0902	St Dn Rg Cr Eb	40,10
DUKE 125	'11 >	KVF-0905	St Dn Rg Cr Eb	77,60
DUKE 390	'14 >	KVF-0909	St Dn Rg Cr Eb	55,95
R 1290 SUPERDUKE	'14 >	KVF-0908	St Dn Rg Cr Eb	97,20
RC 125	'14 >	KVF-0910	St Dn Rg Cr Eb	70,00
RC 390	'14 >	KVF-0910	St Dn Rg Cr Eb	70,00
SUPERDUKE 990	'09-'11	KVF-0906	St Dn Rg Cr Eb	39,35
SUPERMOTO 990	'09	KVF-0904	St Dn Rg Cr Eb	47,60
GLADIUS	/	KVF-0313	St Dn Rg Cr Eb	62,92
GSR 750	'11-'15	KVF-0315	St Dn Rg Cr Eb	48,65
GSX-R 1000	'09-'10	KVF-0312	St Dn Rg Cr Eb	83,35
GSX-R 600/750	'04-'05	KVF-0301	St Dn Rg Cr Eb	68,07
GSX-R 600/750	'06	KVF-0306	St Dn Rg Cr Eb	70,52
GSX-R 600/750	'08-'10	KVF-0309	St Dn Rg Cr Eb	86,55
GSX-S 1000	'15	KVF-0316	St Dn Rg Cr Eb	/
DAYTONA 675/R	'13 >	KVF-0707	St Dn Rg Cr Eb	85,10
SPEED TRIPLE	'11-'15	KVF-0705	St Dn Rg Cr Eb	74,45
STREET TRIPLE	'07-'12	KVF-0703	St Dn Rg Cr Eb	45,35

HONDA

HUSQVARNA

MV AGUSTA

KAWASAKI

KTM

SUZUKI

TRIUMPH

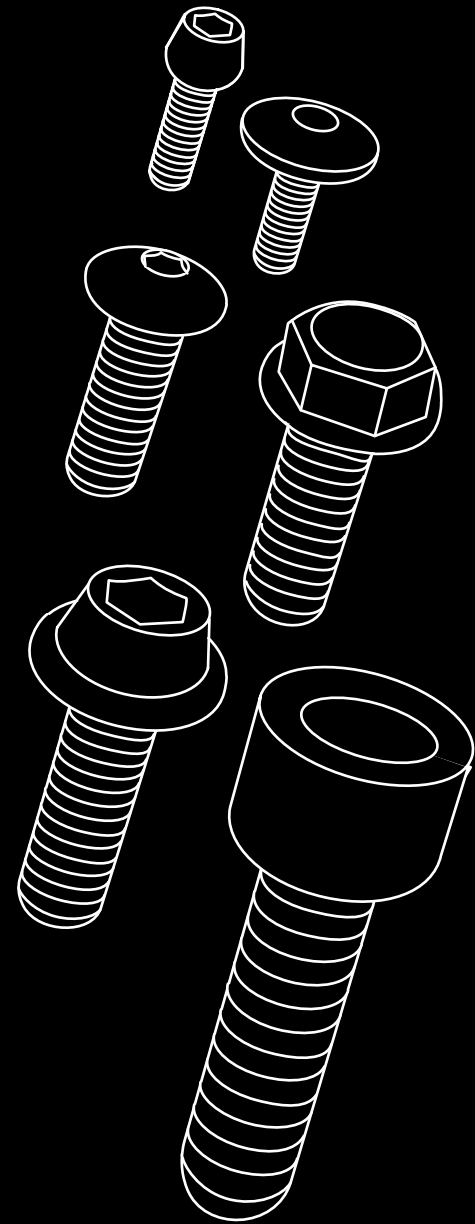

BRAND
TRIUMPH
YAMAHA
APRILIA
BMW
DUCATI
HONDA
MV AGUSTA
KAWASAKI

MODEL	YEAR	CODE	COLOUR	EURO w/o tax
STREET TRIPLE 675R	'13 >	KVF-0706	St Dn Rg Cr Eb	87,05
FZ1 NAKED	/	KVF-0209	St Dn Rg Cr Eb	66,30
FZ8	/	KVF-0206	St Dn Rg Cr Eb	77,50
MT-07	'14 >	KVF-0219	St Dn Rg Cr Eb	66,75
MT-09	'14 >	KVF-0218	St Dn Rg Cr Eb	94,80
MT-09/TRACER	/	KVF-0218-B	St Dn Rg Cr Eb	42,45
R1	'02-'03	KVF-0204	St Dn Rg Cr Eb	59,90
R1	'04	KVF-0207	St Dn Rg Cr Eb	79,55
R1	'09-'14	KVF-0214	St Dn Rg Cr Eb	36,10
R1	'15	KVF-0213	St Dn Rg Cr Eb	62,25
R3	'15	KVF-0220	St Dn Rg Cr Eb	69,95
R6	'03-'05	KVF-0208	St Dn Rg Cr Eb	94,55
TMAX	'08-'11	KVF-0216	St Dn Rg Cr Eb	85,75
TMAX 530	'12 >	KVF-0217	St Dn Rg Cr Eb	67,95
XJ6	'09 >	KVF-0212	St Dn Rg Cr Eb	58,50
YZF R 125	'08-'13	KVF-0205	St Dn Rg Cr Eb	105,55
YZF R 125	'14-'16	KVF-0201	St Dn Rg Cr Eb	86,95

KIT VITI TELAIO / FRAME BOLTS KIT / GESTELL SCHRAUBENSATZ
KIT TORNILLERÍA PARA CHASIS / KIT VISSERIE CHASSIS

MODEL	YEAR	CODE	COLOUR	EURO w/o tax
RS 125	'07-'08	KVT-1000	St Dn Rg Cr Eb	117,70
RS 250	'99	KVT-1009	St Dn Rg Cr Eb	47,50
RS V1000/TUONO	'04 >	KVT-1001	St Dn Rg Cr Eb	56,10
RS V4 FACTORY	'09 >	KVT-1010	St Dn Rg Cr Eb	42,40
TUONO 1000	'02-'05	KVT-1008	St Dn Rg Cr Eb	50,90
TUONO V4	'11-'14	KVT-1005	St Dn Rg Cr Eb	50,25
C 600 SPORT	/	KVT-1103	St Dn Rg Cr Eb	7,80
MULTISTRADA 1200	/	KVT-0808	St Dn Rg Cr Eb	35,95
STREETFIGHTER	/	KVT-0807	St Dn Rg Cr Eb	46,65
CBR 125	'11-'13	KVT-0115	St Dn Rg Cr Eb	10,25
CBR 600 RR	'05-'06	KVT-0108	St Dn Rg Cr Eb	39,20
CBR 600 F	'11-'14	KVT-0114	St Dn Rg Cr Eb	14,20
CBR 1000 RR	'05-'06	KVT-0103	St Dn Rg Cr Eb	121,80
CBR 1000 RR	'08-'14	KVT-0112	St Dn Rg Cr Eb	43,00
CROSSRUNNER	'11 >	KVT-0116	St Dn Rg Cr Eb	23,00
HORNET 600	'07	KVT-0109	St Dn Rg Cr Eb	25,40
BRUTALE 675	/	KVT-0504	St Dn Rg Cr Eb	19,30
BRUTALE 750	'10 >	KVT-0501	St Dn Rg Cr Eb	59,00
BRUTALE 910	'10 >	KVT-0501	St Dn Rg Cr Eb	59,00
BRUTALE 800	/	KVT-0504	St Dn Rg Cr Eb	19,30
BRUTALE 1090/1078/990 R	'10 >	KVT-0501	St Dn Rg Cr Eb	59,00
ER6N	'09-'10	KVT-0409	St Dn Rg Cr Eb	62,35
ER6N	'11-'14	KVT-0410	St Dn Rg Cr Eb	74,50
Z 750	'04-'06	KVT-0403	St Dn Rg Cr Eb	23,10

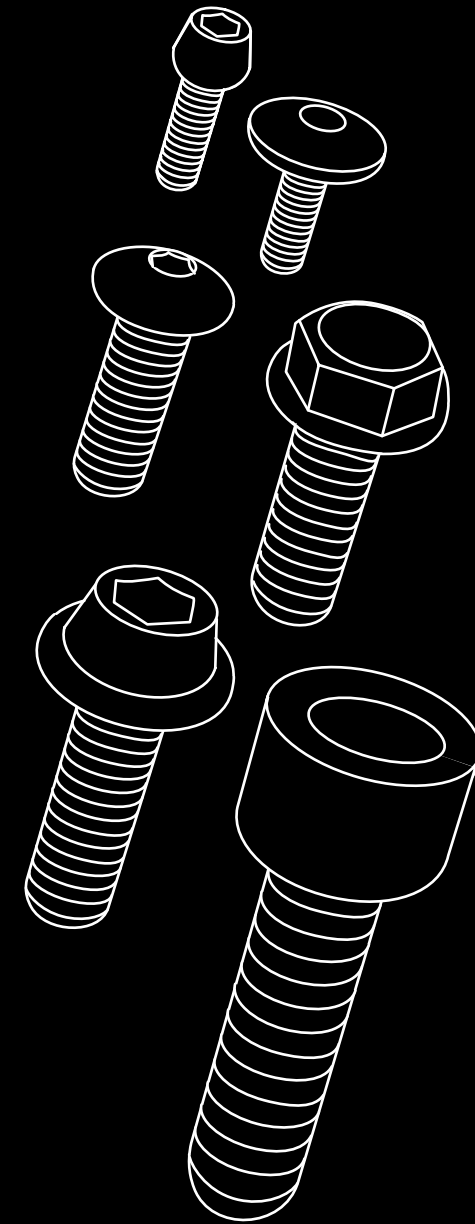

BRAND
KAWASAKI
KTM
SUZUKI
TRIUMPH
YAMAHA
EVOTECH
T-MAX
EVOTECH

MODEL	YEAR	CODE	COLOUR	EURO w/o tax
Z 750	'07-'14	KVT-0406	St Dn Rg Cr Eb	36,10
Z 1000	'03-'06	KVT-0402	St Dn Rg Cr Eb	33,30
Z 1000	'10-'13	KVT-0411	St Dn Rg Cr Eb	65,25
ZX 6R	'03-'04	KVT-0401	St Dn Rg Cr Eb	25,90
ZX 6R	'05	KVT-0405	St Dn Rg Cr Eb	26,60
ZX 6R	'09-'15	KVT-0404	St Dn Rg Cr Eb	60,50
ZX 10R	'04	KVT-0407	St Dn Rg Cr Eb	23,90
ZX 10R	'11-'15	KVT-0413	St Dn Rg Cr Eb	24,00
690 SMC/ENDURO/R	/	KVT-0902	St Dn Rg Cr Eb	88,35
DUKE 125	'11 >	KVT-0905	St Dn Rg Cr Eb	17,30
SUPERDUKE 990	'09-'11	KVT-0906	St Dn Rg Cr Eb	31,95
SUPERMOTO 990	'09	KVT-0904	St Dn Rg Cr Eb	41,15
GLADIUS	/	KVT-0313	St Dn Rg Cr Eb	30,55
GSR 750	'11-'15	KVT-0315	St Dn Rg Cr Eb	3,60
GSX-R 600/750	'04-'05	KVT-0301	St Dn Rg Cr Eb	55,65
GSX-R 600/750	'06	KVT-0306	St Dn Rg Cr Eb	47,95
GSX-R 1000	'09-'10	KVT-0312	St Dn Rg Cr Eb	/
STREET TRIPLE	'07-'12	KVT-0703	St Dn Rg Cr Eb	36,20
FZ1 NAKED	/	KVT-0209	St Dn Rg Cr Eb	62,65
FZ8	/	KVT-0206	St Dn Rg Cr Eb	12,75
R1	'02-'03	KVT-0204	St Dn Rg Cr Eb	35,80
R1	'09-'14	KVT-0214	St Dn Rg Cr Eb	151,45
R6	'03-'05	KVT-0208	St Dn Rg Cr Eb	41,55
XJ6	'09 >	KVT-0212	St Dn Rg Cr Eb	51,45
YZF-R 125	'08-'13	KVT-0205	St Dn Rg Cr Eb	59,35

COOL STRIPES ADESIVI PER RUOTA / WHEEL STICKERS / FELGENRANDAUFKLEBER
ADHESIVO PARA LLANTA / ADHÉSIFS DE ROUES

CODE	COLOUR	EURO w/o tax
STRIP-01 / Cr	ROSSO / RED / ROT	18,00
STRIP-01 / Eb	BLU / BLUE / BLAU	18,00
STRIP-01 / Gr	VERDE / GREEN / GRÜN	18,00
STRIP-01 / Ye	GIALLO / YELLOW / GELB	18,00
STRIP-01 / Or	ARANCIONE / ORANGE / ORANGE	18,00
STRIP-02 / Cr	ROSSO / RED / ROT	18,00
STRIP-02 / Wh	BIANCO / WHITE / WEIß	18,00
STRIP-03 / Es	BIANCO / WHITE / WEIß	18,00
STRIP-03 / F	BIANCO / WHITE / WEIß	18,00
STRIP-03 / Uk	BIANCO / WHITE / WEIß	18,00
STRIP-03 / De	BIANCO / WHITE / WEIß	18,00
STRIP-03 / It	BIANCO / WHITE / WEIß	18,00

IT KIT per una moto
 EN KIT for one motorbike
 DE KIT für ein Motorrad
 ES KIT para una moto
 FR KIT pour une moto

ACCESSORI DUCATI / DUCATI ACCESSORIES / DUCATI ZUBEHÖR
ACCESORIOS DUCATI / ACCESSOIRES DUCATI

POMELLO REGISTRO PRECARICO IDRAULICO / HYDRAULIC PRELOAD ADJUSTER / FEDERBEIN-EINSTELLRAD
POMO AJUSTE PRECARGA HIDRÁULICA / MANETTE DE RÉGLAGE DE PRÉCHARGE HYDRAULIQUE

MODEL	CODE	COLOUR		EURO w/o tax
DIAVEL / HYPERSTRADA	PA-0001	Sl	Dn	60,00
MULTISTRADA 1200 '15	PA-0001	Sl	Dn	60,00



PA-0001

PIATTELLI FRIZIONE / CLUTCH SPRING CAPS / KUPPLUNGSFEDERN
TAPAS DE MUELLES DE EMBRAGUE / COUPELLE DE RESSORT D'EMBRAYAGE

MODEL	CODE	COLOUR		EURO w/o tax
Frizione a secco / Dry clutch	PF-DU1	Sl	Dn	3,00
Kit piattelli/Caps kit (6pcs)	KIT-PF-DU1	Sl	Dn	18,00



PF-DU1

GAMMA COLORI / COLOURS RANGE / FÄRBUNG REICHT
GAMA DE COLORES / GAMME DE COULEURS

DESCRIPTION COLOUR	CODE	COLOUR	
RED	Cr	■	/ / / / / / / / / /
BLACK	Dn	■	/ / / / / / / / / /
GOLD	Rg	■	/ / / / / / / / / /
SILVER	Sl	■	/ / / / / / / / / /
BLUE	Eb	/ / / / /	■ / / / / / / / / / /
TITANIUM	Ti	/ / / / /	/ / / / / ■ / / / / / /
ORANGE	Or	/ / / / /	/ / / / / / ■ / / / / /
GREEN	Gr	/ / / / /	/ / / / / / / ■ / / / /
MATT BLACK	Dks	/ / / / /	/ / / / / / / / ■ / / /



BRAND
DUCATI

BRAND
DUCATI

BRAND
EVOTECH



Video Panigale 1199



Video Evotech Italy



Video Benelli TNT

Enjoy Hi-code App

CONDIZIONI GENERALI DI VENDITA / GENERAL SALES CONDITIONS / ALLGEMEINE GESCHÄFTSBEDINGUNGE

IT

ORDINI Gli ordini per il materiale standard e speciale sono impegnativi per il Cliente.

Una volta avviata la produzione non si accettano annullamenti o riduzioni dell'ordine, salvo il risarcimento da parte del Cliente dei costi del materiale e di lavorazione sostenuti fino al momento della sospensione.

PREZZI I prezzi applicati sono quelli in vigore alla data dell'ordine. Qualora nel corso della fornitura si verificassero sostanziali aumenti del costo del materiale o altri costi di produzione, per cause non imputabili a Evotech S.r.l., sarà facoltà di Evotech S.r.l. stessa adeguare i prezzi ed il costo.

I prezzi indicati nel presente listino si intendono Iva esclusa.

TEMPI DI CONSEGNA Gli ordini sono evasi dallo stock Evotech. I tempi di consegna massimi sono di 15 giorni lavorativi dal ricevimento dell'ordine. Questi tempi di consegna non sono validi in periodi come Agosto, Natale e Pasqua. In caso di slittamento dei termini di consegna, Evotech S.r.l. provvederà a comunicare al Cliente le variazioni.

CONSEGNA La merce ordinata è consegnata franco fabbrica. Sarà a cura del Cliente informare Evotech S.r.l. circa il suo spedizioniere abituale al momento dell'ordine. Le spese di spedizione sono a carico del Cliente. Nel caso in cui il Cliente non abbia esigenze circa lo spedizioniere abituale, Evotech S.r.l. provvederà a consegnare la merce tramite proprio spedizioniere abituale, addebitando al Cliente la totalità delle spese di spedizione. Tali spese comprendono anche le spese di imballaggio necessarie al trasporto.

PAGAMENTI Saranno riconosciuti validi solo i pagamenti nei modi e nei tempi pattuiti. Trascorso il termine di pagamento, Evotech S.r.l. si riserva il diritto di sospendere le consegne di ordini in corso e/o di pretendere il pagamento anticipato nel caso di eventuali ordini successivi, senza riconoscere al committente indennizzi di sorta o risarcimenti. Qualsiasi contestazione riguardante i materiali in corso di fabbricazione o già in possesso del Cliente non libera quest'ultimo dall'effettuare il pagamento alla scadenza stabilità.

GARANZIA Evotech S.r.l. garantisce i prodotti contro difetti di fabbricazione per 5 anni dalla data di acquisto. In caso di prodotti difettosi acquistati direttamente da Evotech S.r.l. si raccomanda al Cliente di comunicare preventivamente il difetto ad Evotech S.r.l. e di inviare a proprie spese il prodotto difettoso, accompagnato da prova di acquisto e descrizione dei difetti in forma scritta. I resi debbono essere autorizzati da Evotech S.r.l. mediante fax di conferma. Evotech S.r.l. si riserva di analizzare i prodotti resi per identificarne le cause di reso. Per il materiale danneggiato da montaggio e/o uso scorretto del prodotto non verranno riconosciute garanzie di alcuna sorta. In caso di acquisto effettuato presso altro rivenditore si raccomanda al Cliente di contattare il rivenditore stesso consegnandogli il prodotto difettoso e la prova di acquisto.

PROPRIETÀ Tutta la merce spedita rimane di proprietà Evotech S.r.l. fino al saldo completo delle fatture.

PRIVACY Evotech S.r.l. si impegna ad utilizzare i dati sensibili del Cliente ai sensi dell'art. 13, D.Lgs 30/06/2003 n. 196. L'archiviazione è in forma cartacea ed informatica. Al Cliente è consentito in ogni momento la variazione dei propri dati tramite comunicazione scritta.

FORO COMPETENTE Qualsiasi controversia inerente ai rapporti commerciali con Evotech S.r.l., sarà di competenza del Tribunale di Trento.

VALIDITÀ Il presente listino prezzi è stato dato alle stampe il 1° gennaio 2016. Ogni condizione e prezzo in esso elencato è valido a partire dal 1° gennaio 2016 fino ad ulteriore revisione.

EN

ORDERS All orders are binding once production has started. Any cancellation or reduction of an order will not be accepted, unless the customer pays an indemnity for any material and labor costs incurred by Evotech.

PRICES Prices are in force from the date of order. Prices are in force from the date of order. If material and labor costs increase during the supply of goods, due to causes beyond Evotech's control, Evotech will revise their prices. All prices in this catalogue don't include VAT.

DELIVERY TIME Orders will be dispatched from Evotech in 15 working days.

DELIVERY Goods are dispatched ex factory (at buyer's risk). The Buyer has to inform Evotech of his usual forwarding agent. If the customer does not have a particular forwarding agent then Evotech will deliver the goods through their own courier, all expenses will be charged to the customer. These charges will also include packing expenses.

PAYMENT Payment must be made according to the agreed way and within the agreed time scale. If payment becomes overdue, Evotech has the right to stop the delivery and to claim a payment in advance without paying any compensation to the Buyer. Any objection about materials in progress or in the customer's hands does not relieve the customer of the due payment.

WARRANTY Evotech guarantees all goods against any manufacturing defects for up to 5 years, starting from the purchase date. In case of faulty items, which have been bought directly from Evotech, we recommend you contact Evotech immediately. The faulty product must be returned, at the Buyers costs, together with a proof of purchase and a written description of the defect. Returned items have to be authorized by Evotech by fax. Evotech has the right to analyze the returned items in order to check the cause of the damage. A guarantee will not be valid if items are damaged because of incorrect assembly and/or incorrect use. If the product has been purchased from a retailer, Evotech recommends you contact them directly advising them of the fault and including a proof of purchase.

OWNERSHIP Evotech owns all dispatched goods until the invoice has been settled in full.

PRIVACY Evotech will use the customer's details according to the article no.13, D.Lgs 30/60/2003 n.196. The data will be kept on written and digital files. The customer can modify his details at any time by written notification.

JURISDICTION Any trade debate will be resolved by the Trento's tribunal.

VALIDITY This price list was printed on 1st January 2016. Terms and prices are valid from 1st January 2016 until further notice.

DE

BESTELLUNGEN Alle Bestellungen sind verbindlich, sobald die Produktion begonnen hat. Stornierungen oder Reduzierungen von Bestellungen sind nicht möglich, es sei denn, wenn der Kunde eine Entschädigung für Material - und Lohnkosten von EVOTECH übernimmt.

PREISE Die Preise gelten ab dem Zeitpunkt der Bestellung. Steigen Material- und Lohnkosten während der Auftragsabwicklung und liegen die Gründe nicht im Einflussbereich von EVOTECH dann behält sich EVOTECH vor, die Preise zu überarbeiten. Sämtliche Katalogpreise enthalten keine Mehrwertsteuer.

LIEFERZEIT Bestellungen werden von EVOTECH innerhalb von 15 Tagen versendet.

AUSLIEFERUNG Die Waren werden ab Werk auf Gefahr des Käufers versandt. Der Käufer hat EVOTECH über seinen Spediteur zu informieren. Hat der Käufer keinen speziellen Spediteur, dann wird EVOTECH den Versand über dessen Spediteur vornehmen. Verpackungs- und Versandkosten gehen zu Lasten des Käufers.

BEZAHLUNG Die Bezahlung muss nach der vereinbarten Weise innerhalb des vereinbarten Zeitraums vorgenommen werden. Erfolgt ein Verzug bei der Bezahlung, behält sich Evotech vor, den gesamten Rechnungsbetrag vor Auslieferung einzufordern. Hierbei hat der Kunde kein Recht zur Forderung von Teillieferungen.

GEWÄHRLEISTUNG UND GARANTIE Evotech übernimmt Gewährleistungsansprüche gegen jegliche Fabrikationsfehler bis zu 5 Jahren, beginnend abdem Kaufdatum. Im Falle von fehlerhaften Produkten, die direkt bei Evotech gekauft wurden, empfehlen wir Ihnen, den sofortigen Kontakt mit uns aufzunehmen. Das defekte Produkt muß zur Prüfung an uns zurückgesendet werden. Zudem benötigen wir den Kaufbeleg und eine Beschreibung des Mangels. Sie können Ihre Vertragserklärung innerhalb von einem Monat ohne Angabe von Gründen in Textform (z. B. Brief, Fax, E-Mail) oder - wenn Ihnen die Sache vor Fristablauf überlassen wird - durch Rücksendung der Sache widerrufen. Die Frist beginnt nach Erhalt dieser Belehrung in Textform, jedoch nicht vor Eingang der Ware beim Empfänger (bei der wiederkehrenden Lieferung gleichartiger Waren nicht vor Eingang der ersten Teillieferung) und auch nicht vor Erfüllung unserer Informationspflichten gemäß § 312c Abs. 2 BGB in Verbindung mit § 1 Abs. 1, 2 und 4 BGB-InfoV sowie unserer Pflichten gemäß § 312e Abs. 1 Satz 1 BGB in Verbindung mit § 3 BGB- InfoV. Zur Wahrung der Widerrufsfrist genügt die rechtzeitige Absendung des Widerrufs oder der Sache. Das Widerrufsrecht findet Anwendung bei Verträgen zwischen Privatleuten und Evotech, nicht aber zwischen Evotech und einem anderen Unternehmen. Der Widerruf ist zu richten an: Evotech S.r.l. Via da Borgo, 14 38059 VILLA AGNEDO (TN) ITALY

WIDERRUFSFOLGEN

Im Falle eines wirksamen Widerrufs sind die beiderseits empfangenen Leistungen zurückzugewähren und ggf. gezogene Nutzungen (z. B. Zinsen) herauszugeben. Können Sie uns die empfangene Leistung ganz oder teilweise nicht oder nur in verschlechtertem Zustand zurückgewähren, müssen Sie uns insoweit ggf. Wertersatz leisten. Bei der Überlassung von Sachen gilt dies nicht, wenn die Verschlechterung der Sache ausschließlich auf deren Prüfung - wie sie Ihnen etwa im Ladengeschäft möglich gewesen wäre - zurückzuführen ist. Für eine durch die bestimmungsgemäße Ingebrauchnahme der Sache entstandene Verschlechterung müssen Sie keinen Wertersatz leisten. Paketversandfähige Sachen sind auf unsere Gefahr zurückzusenden. Sie haben die Kosten der Rücksendung zu tragen, wenn die gelieferte Ware der bestellten

entspricht und wenn der Preis der zurückzusendenden Sache einen Betrag von 40 Euro nicht übersteigt oder wenn Sie bei einem höheren Preis der Sache zum Zeitpunkt des Widerrufs noch nicht die Gegenleistung oder eine vertraglich vereinbarte Teilzahlung erbracht haben Anderenfalls ist die Rücksendung für Sie kostenfrei. Nicht paketversandfähige Sachen werden bei Ihnen abgeholt. Verpflichtungen zur Erstattung von Zahlungen müssen innerhalb von 30 Tagen erfüllt werden. Die Frist beginnt für Sie mit der Absendung Ihrer Widerrufserklärung oder der Sache, für uns mit deren Empfang.

EIGENTUMSVORBEHALT Wir behalten uns das Eigentum an der Kaufsache bis zum Eingang der vollständigen Zahlung aus dem Vertrag vor.

DATENSCHUTZ Evotech speichert und übermittelt die auftragsbezogenen persönlichen Daten des Kunden ausschließlich zur Bearbeitung und Abwicklung seiner Bestellung. Die Rechtsgrundlage hierfür bildet No.13, D.Lgs 30/60/2003 n.196. Änderungen seiner Kundendaten kann den Kunde ausschließlich schriftlich vornehmen.

GERICHTSSTAND Sofern es sich bei dem Käufer um einen Kaufmann, eine juristische Person des öffentlichen Rechts handelt oder der Käufer keinen allgemeinen Gerichtsstand im Inland hat, ist der Gerichtsstand das Tribunal in Trento/Italien.

GÜLTIGKEIT Dieser preislste wurde am 1.Januar 2016 gedruckt. Termine und Preise sind gültig vom 1. Januar 2016 bis auf weiteres.



PATENTED

Brevettato - *Patented* - Patentiert
Patentado - Breveté



Omologato - *Homologated* - Homologiert
Homologado - Homologué



5 anni di garanzia - *5 years warranty* - 5 Jahre Garantie
5 años de Garantía - Garantie du produit 5 ans

CONDICIONES GENERALES DE VENTA / CONDITIONS GENERALES DE VENTE

ES

PEDIDOS Todos los pedidos de material estándar y especial son vinculantes para el cliente. Cualquier cancelación o reducción del pedido no será aceptada una vez fabricado el material, salvo pago de indemnización del cliente en concepto de preparación de material por parte de Evotech.

PRECIOS Los precios de venta serán los vigentes en la fecha del pedido. En caso de incremento de los precios por causas ajenas a nuestra compañía, Evotech podrá ajustar los precios. Los precios del presente catalogo no incluyen IVA.

TIEMPO DE ENTREGA Los pedidos serán enviados por Evotech en un máximo de 15 días laborables. Esta estimación puede variar en períodos puntuales como el mes de agosto, Navidad y Semana Santa. En caso de retrasos de entrega superiores al plazo fijado, Evotech se compromete a informar al cliente.

ENTREGA Los pedidos serán despachados en fábrica. En caso contrario, el cliente informará de su agencia de mensajería o si desea que el producto sea enviado a través de nuestra agencia de transportes. En este caso, los gastos de envío serán cargados en la factura del material. Este coste incluirá los gastos de manipulación.

PAGO El pago será realizado en base a las condiciones acordadas. En caso de impagos, Evotech se reserva el derecho de paralizar los envíos hasta la recepción de los pagos pendientes, renunciando el cliente a cualquier tipo de compensación. Cualquier objeción sobre los materiales servidos no exime al cliente de su pago.

GARANTÍA Evotech garantiza todos sus productos contra defectos de fabricación durante 5 años a partir de la fecha de compra. En caso de material defectuoso que haya sido comprado directamente a Evotech, recomendamos contacten con nosotros inmediatamente. El producto defectuoso será enviado a Evotech a portes pagados junto con el comprobante de compra y una descripción detallada del problema. La devolución del material deberá ser aceptada previamente por Evotech vía fax. Evotech se reserva el derecho de analizar el producto devuelto para la comprobación de los posibles defectos de fabricación. La garantía quedará anulada automáticamente en caso de uso o montaje incorrecto. Si el producto ha sido adquirido en un punto de venta Evotech, recomendamos contactar directamente con la tienda, adjuntando el ticket de compra.

PROPIEDAD Los productos son pertenencia de Evotech hasta su completo pago.

PRIVACIDAD Los datos de contacto y facturación del cliente pasan a formar parte de una base de datos digital propiedad de Evotech S.r.l. de acuerdo a la ley italiana de protección de datos (art. 13, D. Lgs 30/06/2003 n. 196). El vendedor tiene derecho a su modificación o cancelación mediante notificación escrita.

JURISDICCION Ambas partes se someten a la jurisdicción de los tribunales de Trento, renunciando a cualquier otro foro que pudiera corresponderles.

VALIDEZ La lista de precios ha sido impreso el 1 enero de 2016. Los precios y condiciones son válidos a partir de la fecha hasta nueva orden.

FR

LES COMMANDES Les commandes pour le matériel standard et spécial engagent le client. Une fois la production lancée, aucune annulation ou modification de la commande ne sera acceptée, sauf indemnisation de la part du client des coûts relatifs au matériel et au travail exécuté jusqu'à l'arrêt de la fabrication.

LES PRIX Les prix appliqués sont ceux en vigueur à la date de la commande. Dans le cas où au cours de la fourniture des augmentations du coût des matériaux ou autres coûts de production se produiraient, pour cause non imputable à Evotech S.r.l., il en sera de la faculté même d' Evotech S.r.l d'en ajuster les prix et le coût. Les prix indiqués dans le tarif s'entendent HT.

DELAI DE LIVRAISON Les commandes sont prélevées du stock d'Evotech. Les délais de livraison maximum sont de 15 jours ouvrés à compter de la réception de la commande. Ces délais de livraisons ne sont pas valables en période d'Août, de Noël et de Pâques. En cas de dépassement du délai de livraison, Evotech S.r.l. veillera à informer le client des changements de délai.

LIVRASION La marchandise commandée est livrée en franco usine. Au moment de la commande, il incombe au client d'informer Evotech S.r.l au sujet de son transporteur habituel. Les frais de transport sont à la charge du client. Dans le cas où le client n'a aucune exigence au sujet du transporteur, Evotech S.r.l. expédiera la marchandise par le biais de son transporteur habituel et les frais de transport lui seront facturés. Ces frais comprennent les frais d'emballage nécessaires au transport.

PAIEMENT Les règlements seront à réaliser en fonction des conditions de paiements accordés à l'origine. En cas de retard de paiement, Evotech S.r.l se réserve le droit de suspendre les livraisons des commandes en cours et/ ou de réclamer le règlement anticipé dans le cas de nouvelles commandes. Quelques soient les contestations à l'égard de la marchandise en cours de production ou déjà livrée au client, la marchandise devra être réglée à l'échéance prévue.

GARANTIE Evotech S.r.l. garantit les produits contre les défauts de fabrication pendant 5 ans à compter de la date d'acquisition. En cas de produits défectueux acquis directement chez Evotech S.r.l , nous recommandons au client d'informer préalablement Evotech S.r.l. du défaut et de le lui retourner à ses propres frais, accompagné de la preuve d'achat et d'une description des défauts par écrit. Seule une confirmation par fax de la part d' Evotech S.r.l. autorisera le retour de la pièce. Evotech S.r.l se réserve le droit d'analyser les produits rendus pour en identifier les causes du retour. Pour la marchandise endommagée lors du montage et/ou mauvaise utilisation, la garantie ne s'appliquera pas. En cas d'achat réalisé auprès d'autres revendeurs, nous recommandons au client de contacter directement le revendeur concerné et de lui faire parvenir l'article défectueux et la preuve d'achat.

PROPRIÉTÉ Toutes les marchandises expédiées restent la propriété d' Evotech S.r.l. jusqu'au règlement total de la facture.

PRIVÉ Evotech S.r.l s'emploie à utiliser toutes les données sur le client au sens de l'art. 13,D.Lgs 3006/2003 n.196. L'archivage est informatisé. Le client est tenu de prévenir par écrit Evotech S.r.l de toute modification le concernant.

LITIGE Pour toute controverse concernant les rapports commerciaux avec Evotech S.r.l., la compétence du tribunal de Trento sera reconnue.

VALIDITY La présent liste de prix a été imprimé le 1 janvier 2016 Chaque conditions et prix mentionnés sont valables à compter du 1 janvier 2016 et jusqu'à une révision ultérieure.



Evotech S.p.A.
Località Palù 38055 Grigno (TN)
Tel. +39 0461 780184
Fax. +39 0461 78270

www.evotech-rc.it

Enjoy Hi-code App



info@evotech-rc.it

